

TRONIC 100 TRONIC 100 TRONIC 100  
TRONIC 100 TRONIC 100 TRONIC 100  
TRONIC 100 TRONIC 100 TRONIC 100

# GEbruikers- & INSTALLATIEHANDLEIDING

## MANUEL DE MONTAGE

TRONIC 100 TRONIC 100 TRONIC 100  
TRONIC 100 TRONIC 100 TRONIC 100  
TRONIC 100 TRONIC 100 TRONIC 100  
TRONIC 100 TRONIC 100 TRONIC 100  
TRONIC 100 TRONIC 100 TRONIC 100  
TRONIC 100 TRONIC 100 TRONIC 100  
TRONIC 100 TRONIC 100 TRONIC 100  
TRONIC 100 TRONIC 100 TRONIC 100  
TRONIC 100 TRONIC 100 TRONIC 100  
TRONIC 100 TRONIC 100 TRONIC 100  
TRONIC 100 TRONIC 100 TRONIC 100  
TRONIC 100 TRONIC 100 TRONIC 100  
TRONIC 100 TRONIC 100 TRONIC 100  
TRONIC 100 TRONIC 100 TRONIC 100  
TRONIC 100 TRONIC 100 TRONIC 100  
TRONIC 100 TRONIC 100 TRONIC 100  
TRONIC 100 TRONIC 100 TRONIC 100  
TRONIC 100 TRONIC 100 TRONIC 100  
TRONIC 100 TRONIC 100 TRONIC 100  
TRONIC 100 TRONIC 100 TRONIC 100  
TRONIC 100 TRONIC 100 TRONIC 100  
TRONIC 100 TRONIC 100 TRONIC 100  
TRONIC 100 TRONIC 100 TRONIC 100

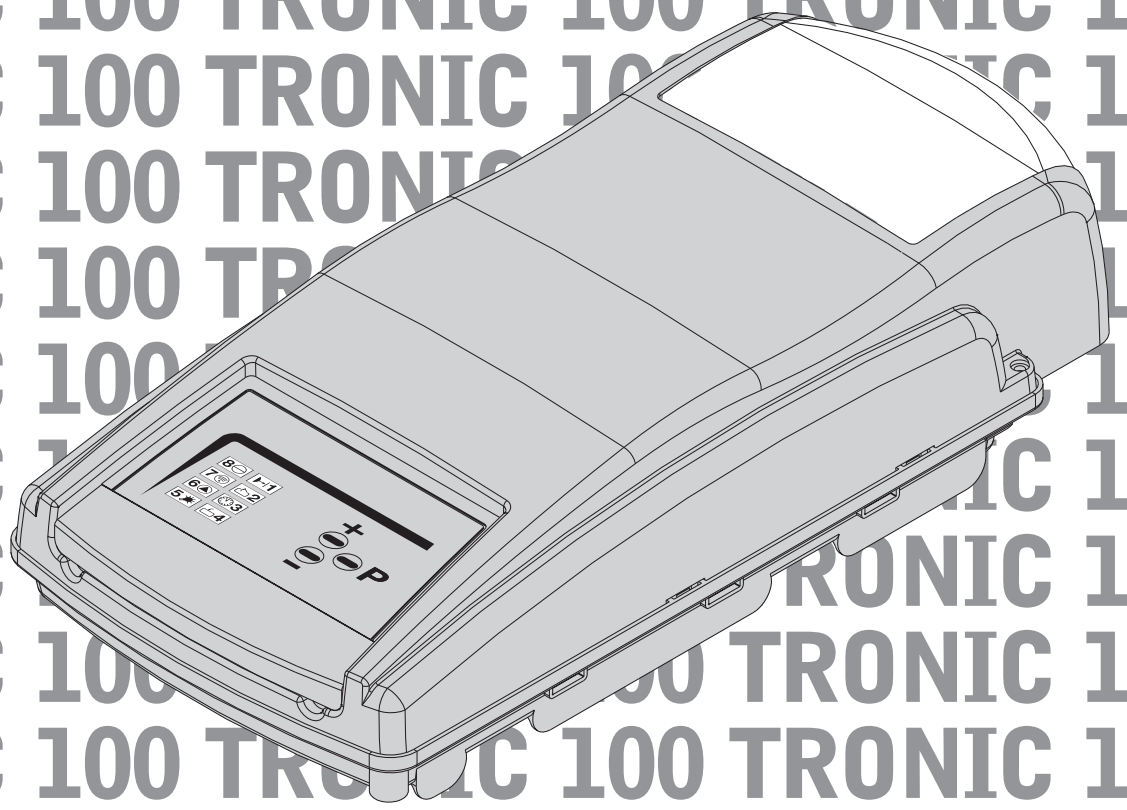

Modular Automation Corporation

**⚠ BELANGRIJKE VEILIGHEIDSINSTRUCTIES VOOR DE INSTALLATIE**  
**WAARSCHUWING – INCORRECTE INSTALLATIE KAN LEIDEN TOT ERNSTIG**  
**LETSEL. VOORKOM PERSOONLIJK LETSEL EN BESCHADIGING VAN DE**  
**APPARATUUR. LEES DEZE INSTRUCTIES AANDACHTIG DOOR VOORDAT U**  
**DE AANDRIJVING MONTEERT.**

Controleer of de garagedeur in goede staat en balans is en dat hij goed open en dicht gaat alvorens u de aandrijving installeert.

- Gebruik geen extra krachten om te compenseren voor een moeilijk lopende garagedeur. Overdadig benodigde krachten voorkomen een veilig werkende Safety Reverse Systeem of kunnen de garagedeur beschadigen.
- Kleding kan vastraken in hendels en andere uitsteeksels. Verwijder alle touwen, hendels, haken, beugels en andere uitsteeksels van de deur. Draag geen wijde losse kleding.
- Plaats het wandcontact (drukknop) in het zicht van de garagedeur, maar weg van elk beweegbaar onderdeel van de garagedeur. Het is raadzaam het wandcontact hoog genoeg, buiten bereik voor kinderen, te plaatsen.
- **De Safety Reverse Systeem test is erg belangrijk.** Een dichtgaande garagedeur moet stoppen en terug opengaan indien zich er een obstakel onder de deur bevindt. **Het niet correct instellen** kan resulteren in schade of letsel. Herhaal deze test maandelijks en pas, indien noodzakelijk, instellingen aan (zie Menu ④ en Menu ⑤ op blz. 13 van deze handleiding).

Plaatselijke veiligheidsvoorschriften in acht nemen. Netvoeding- en laagspanningsbedradingen absoluut gescheiden leggen.

- Indien er geen tweede toegangsdeur tot de garage is, moet men een noodontgrendeling van buitenaf installeren. Deze accessoire maakt het mogelijk toegang tot de garagedeur te krijgen in geval van een stroomuitval.
- Voor het openen van de behuizing de aandrijving eerst loskoppelen van de netspanning!
- Controleer de installatie, met name de kabels, veren en bevestigingen op tekenen van slijtage, beschadiging of het niet goed in balans zijn. Breng zelf geen veranderingen aan deur, veren of kabels aan, daar een niet goed gebalanceerde deur letsel kan veroorzaken.
- Sloten of grendels op de deur verwijderen of buiten gebruik stellen.

**BELANGRIJKE VEILIGHEIDSOPMERKING**

Houd mensen en dieren uit de buurt van bewegende deuren. Laat iedereen zien hoe de aandrijving veilig gebruikt kan worden. Open de deur alleen als deze volledig zichtbaar is. Laat nooit iemand onder een bewegende deur doorlopen. Laat geen kinderen met de deur of afstandsbediening spelen.

Bewaar dit handboek voor toekomstig onderhoud, afstelling en reparaties.

### INTRODUCTIE

Gefeliciteerd met de aanschaf van uw nieuwe garagedeuropener. Het is een resultaat van een zorgvuldig ontwerp en nauwkeurige productietechnieken. Deze garagedeuropener biedt u duurzaam gebruiksgemak. Al onze producten zijn fabriekstest en garanderen optimale kwaliteit en veiligheid.

Om schade aan aandrijving of garagedeur te voorkomen en om te voldoen aan de Machine-richtlijnen dient u de aandrijving volgens instructies in deze handleiding in acht te nemen.

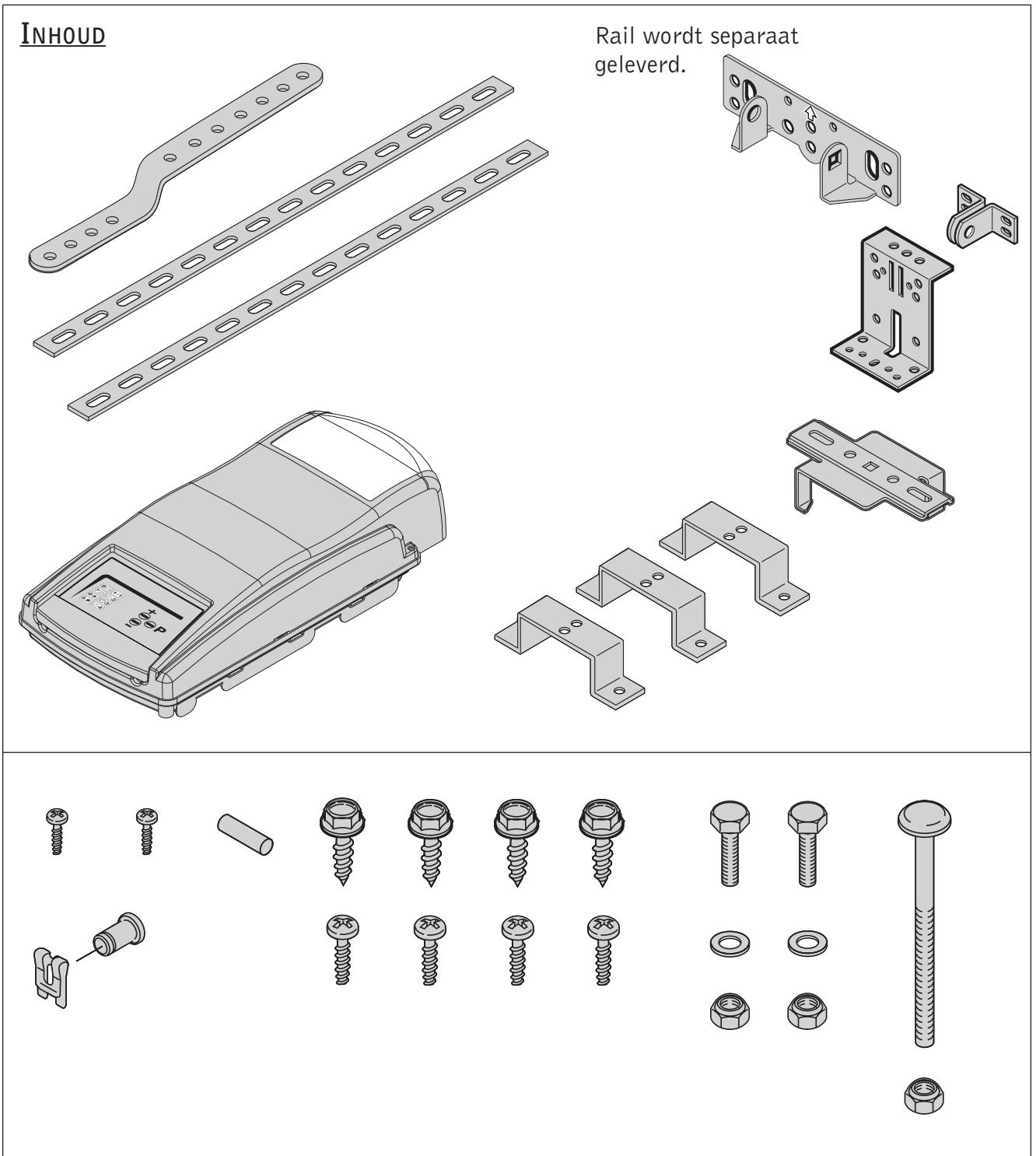

## VEILIGHEIDSVORZIENINGEN

- **Automatische terugloop**  
Een sluitende deur stopt en opent zich automatisch binnen 2 seconden indien de deur een obstakel raakt.
- **Automatische looptijdbe grenzing**  
Sluitende deur stopt en opent zich indien deze niet geheel is gesloten binnen 88 seconden (instelbaar 30 - 240 seconden).
- **Safety Stop**  
Ope ngangende deur stopt binnen 2 seconden zodra deze tegen een obstakel komt.
- **Fotocel**  
Voor extra veiligheid bevelen wij een fotocel aan. Indien een voorwerp of persoon de infra-rood straal onderbreekt terwijl de deur sluit, stopt de deur en keert deze terug in stand open zonder dat iemand de deur zelf heeft aangeraakt.

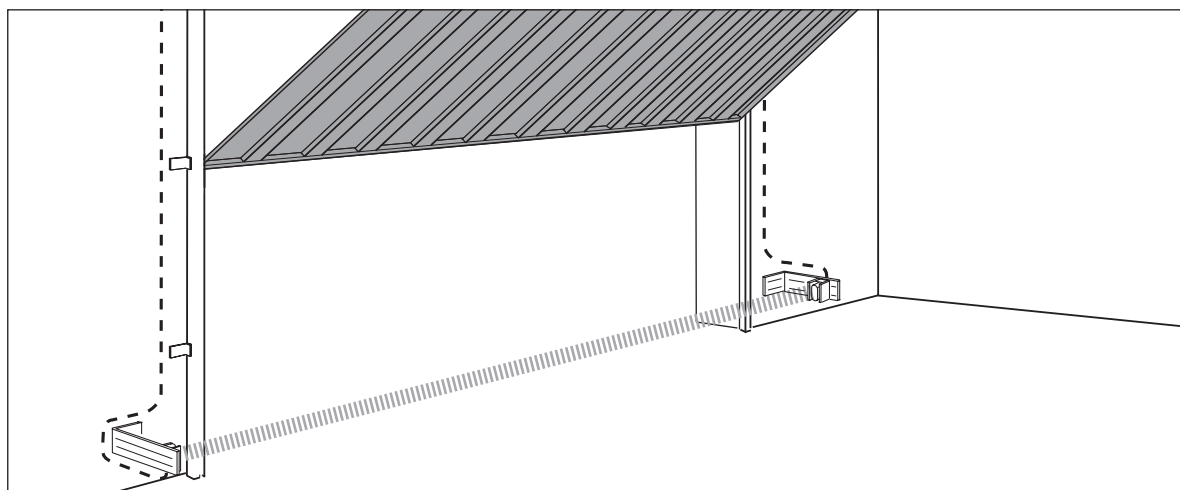

## BELANGRIJK

Voor optimale veiligheid moet men de onafhankelijk open en dichtloop krachtbe grenzing (zie Menu ④ en Menu ⑤ op blz. 13 van deze handleiding) instellen en regelmatig testen.

## MONTAGE-INSTRUCTIES

**Let op:** Indien de opener is geleverd met een tweedelige rail dient men de montage-instructies, geleverd bij rail, in acht te nemen.

### 1 Plaats grijze tandwieladapter op motoraandrijfas.

De rail samen met de 2 klembeugels aan de aandrijving vastschroeven.  
Zorg dat de schroeven goed vastgedraaid worden.

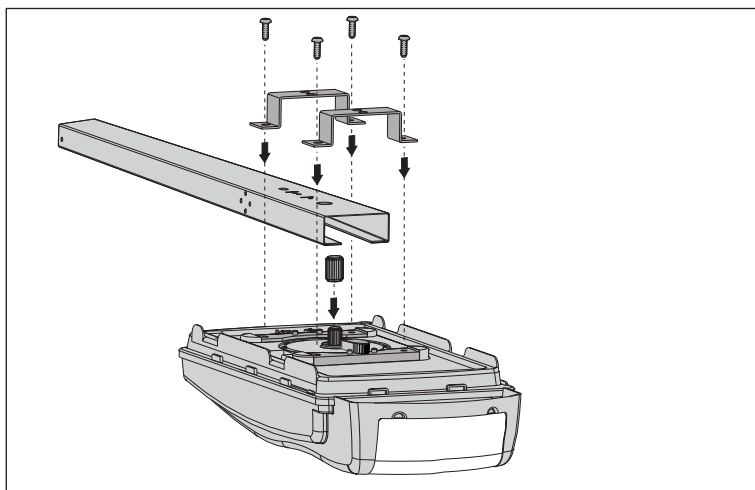

### 2 Monteer de inschakelpal en de trekstang op het wagentje.

- Verwijder de pal van zijn transport ligplaats en druk hem in de voorziene plaats op de loopwagen. (zie fig. 1)
- Schroef de trekstang in de loopwagen. Let op de positie van de trekkoord (zie fig. 2) om beschadiging en incorrecte werking te voorkomen

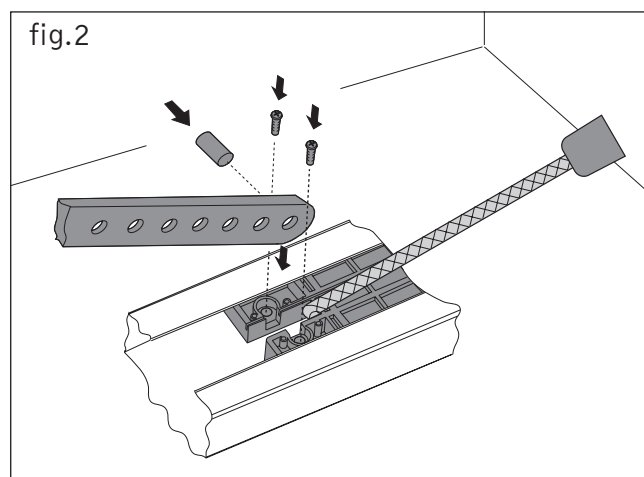
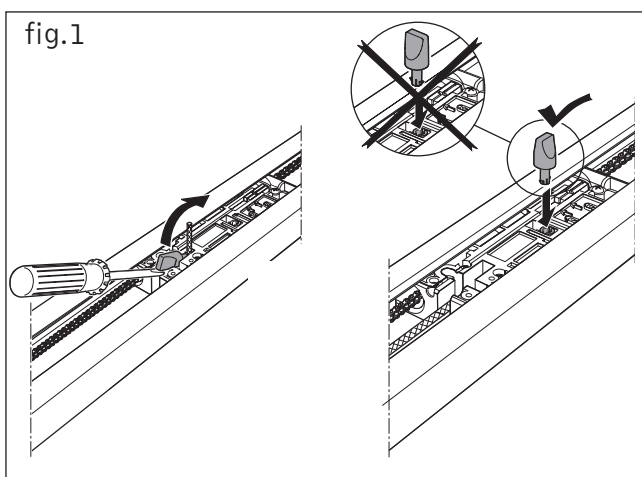

### 3 Snelontkoppeling.

- a. Om de loopwagen te ontgrendelen: trek aan de touw "a". De loopwagen blijft ontgrendeld.(zie fig. 3)
- b. Om de loopwagen terug in te schakelen: beweeg de rode pal in de richting van de pijl en start de opener (zie fig. 4)

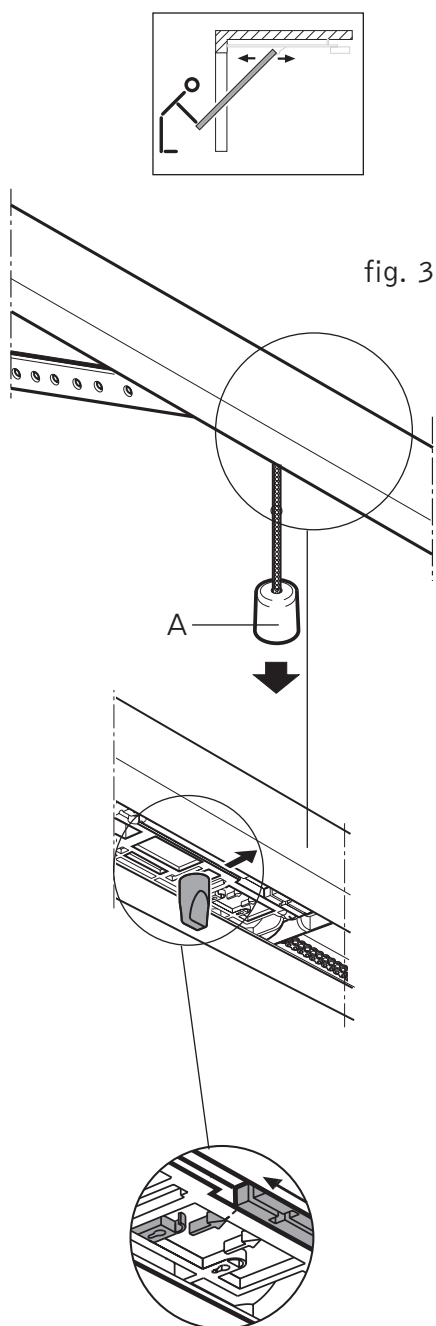

fig. 3

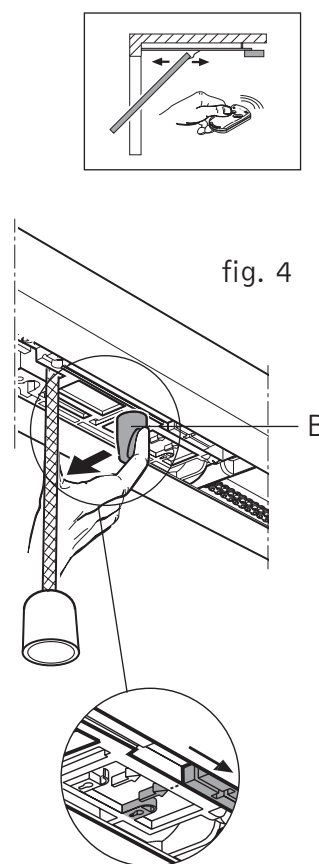
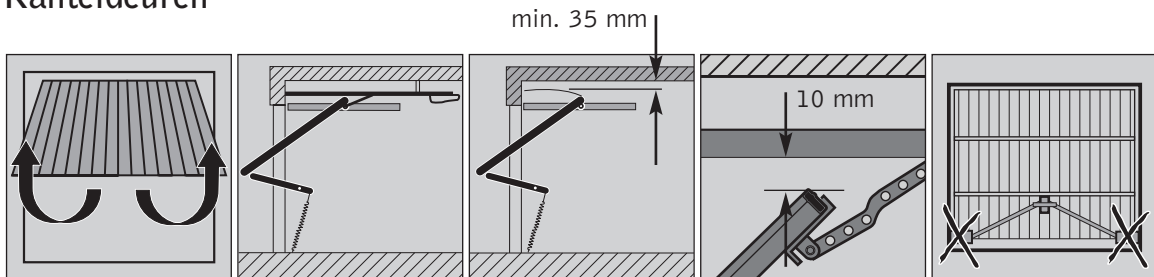

fig. 4

## SELECTEER UW TYPE GARAGEDEUR

Voordat u de aandrijving gaat monteren dient u te controleren of de opener geschikt is voor uw type garagedeur. Bepaal uw deurtype in Stap **4A**, **4B**, **4C** of **4D** en volg nauwkeurig de individuele instructies. Voor alle overige deurtypen dient u contact op te nemen met uw leverancier. Speciale accessoires of aanpassingen kunnen noodzakelijk zijn.

### 4A Kanteldeuren



- Monteer deurbeugel (a) in het midden van de deur. Bevestig beugel (b) van de rail in het midden boven de deur (op het deurkozijn of op de draagbalk) zodanig dat er minstens 10 mm. afstand is tussen het hoogste punt van de deur en de onderkant van de rail.

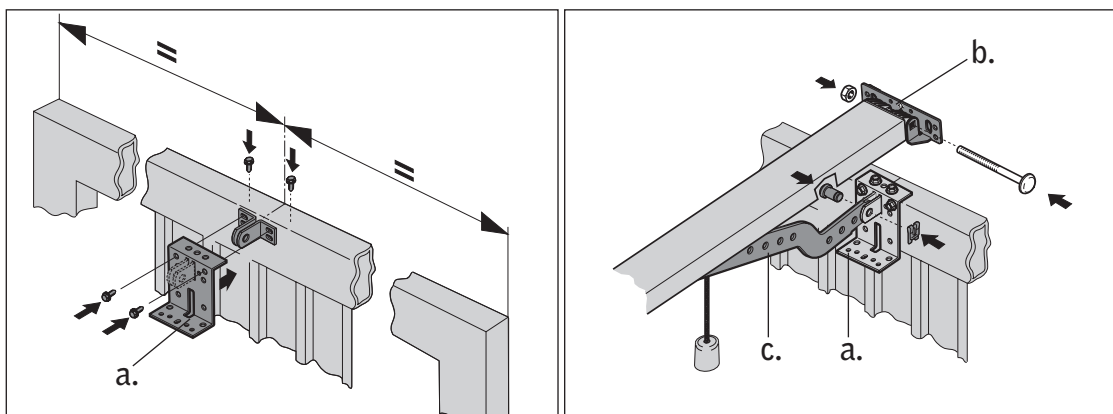

- De aandrijving met behulp van een ondersteuning horizontaal stellen en bevestigen (fig. d).

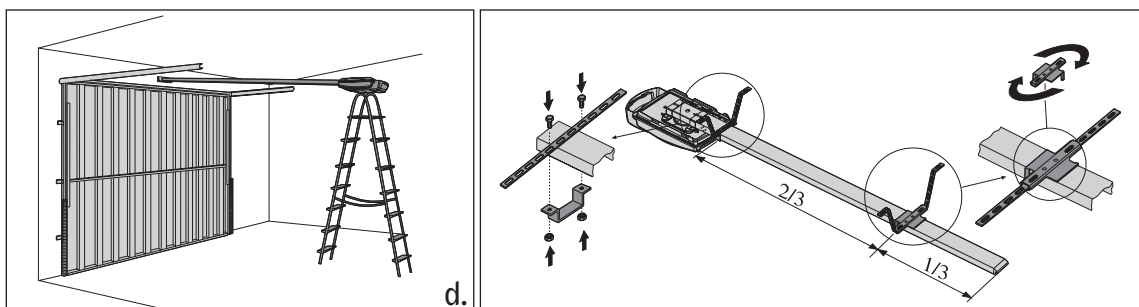

- Ontkoppel loopwagen. Open of sluit de deur langzaam.
- Trekstang (c) aan deurbeugel (a) koppelen.

**Let op!** Sloten of grendels op de deur verwijderen of buiten gebruik stellen.

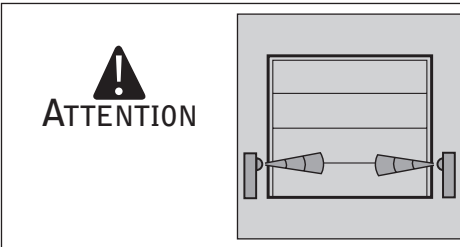
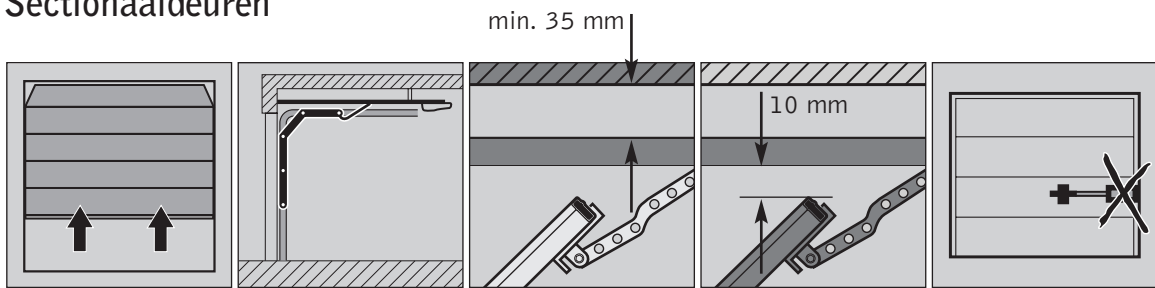
**4B****Sectionaaldeuren**

Een fotocel wordt ten zeerste aanbevolen (niet inbegrepen, apart te bestellen).

- Monteer deurbeugel (a) zoals aangegeven in het midden van de deur.

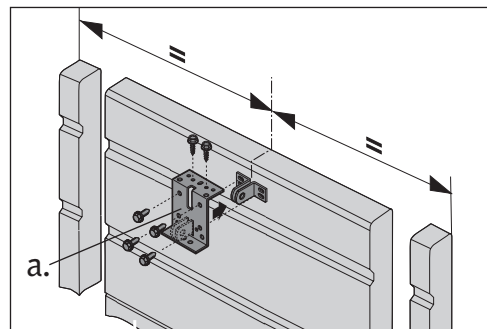

- Bevestig beugel (b) van de rail in het midden boven de deur (op het deurkozijn of op de draagbalk) zodanig dat er minstens 10 mm. afstand is tussen het hoogste punt van de deur en de onderkant van de rail.

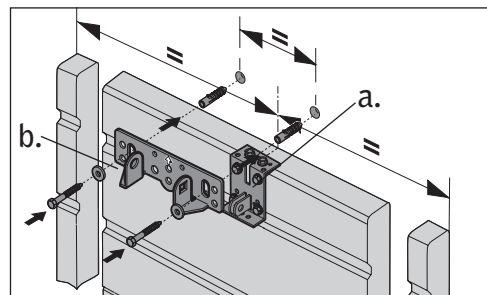

- De aandrijving met behulp van een ondersteuning horizontaal stellen en bevestigen (fig. d).

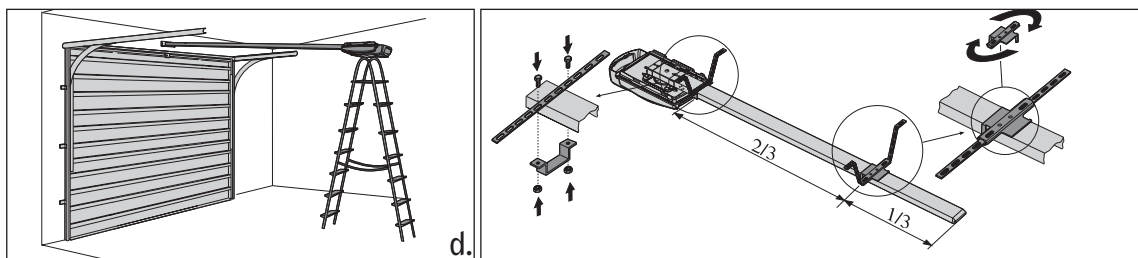

- Ontkoppel loopwagen.  
Open of sluit de deur langzaam.
- Trekstang (c) aan deurbeugel (a) koppelen.

Let op! sloten of grendels op de deur verwijderen of buiten gebruik stellen.

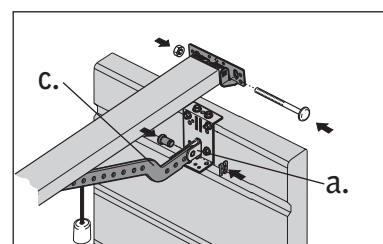



## 4C Binnen de gevel draaiende kanteldeur

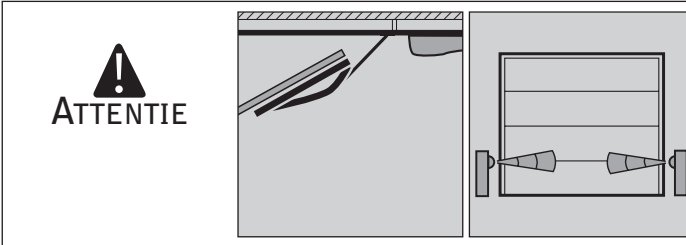
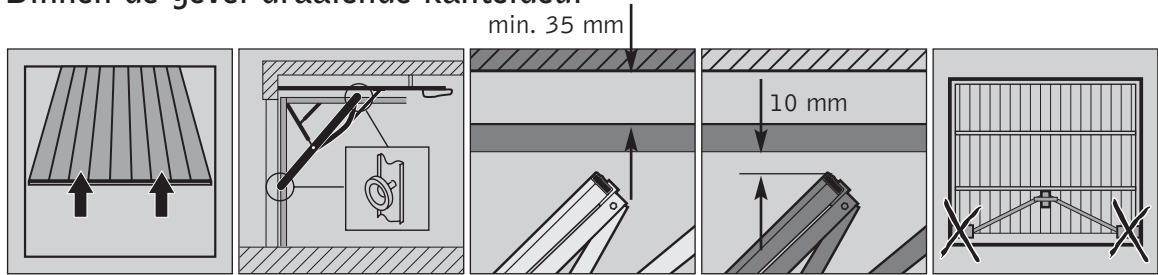

Speciale curvenarm (zie tekening) is noodzakelijk (niet inbegrepen). Een fotocel wordt ten zeerste aanbevolen (niet inbegrepen, apart te bestellen).

- Monteer beugel (b) van de rail in het midden boven de deur (op het deurkozijn of op de draagbalk) zodanig dat er minstens 10 mm. afstand is tussen het hoogste punt van de deur en de onderkant van de rail.
- Monteer de curvenarm volgens de instructies van de leverancier van de arm.
- De aandrijving met behulp van een ondersteuning horizontaal stellen en bevestigen (d).

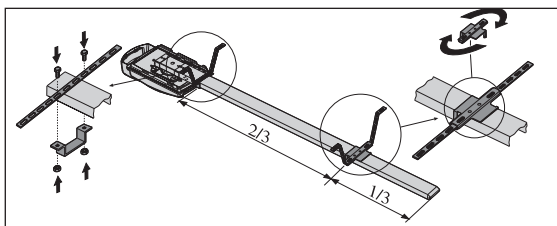
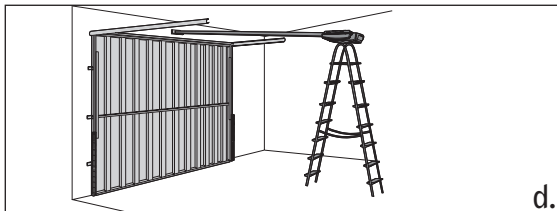
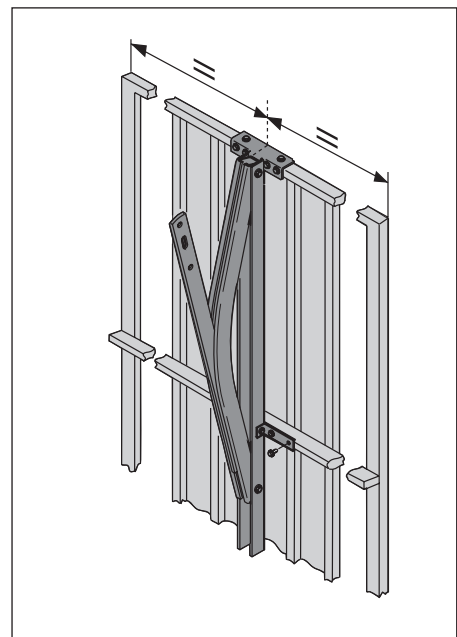
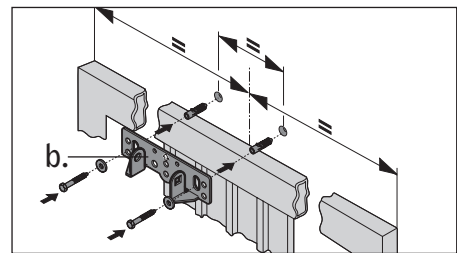

- Ontkoppel loopwagen. Open of sluit de deur langzaam.
- De deur geheel openen en trekstang met curvenarm verbinden. Sluit deur handmatig en controleer of de afstand tussen loopwagen en deur min. 165 mm is.

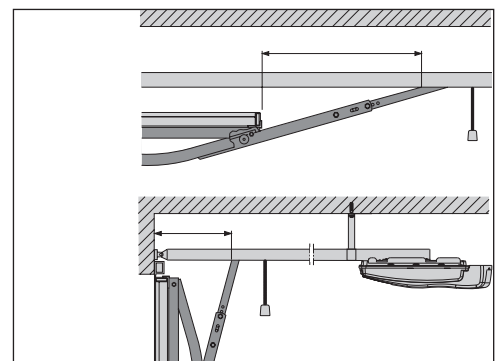

## 4D Verticaal geleide deur

(waarvan de helft buiten de gevel blijft)

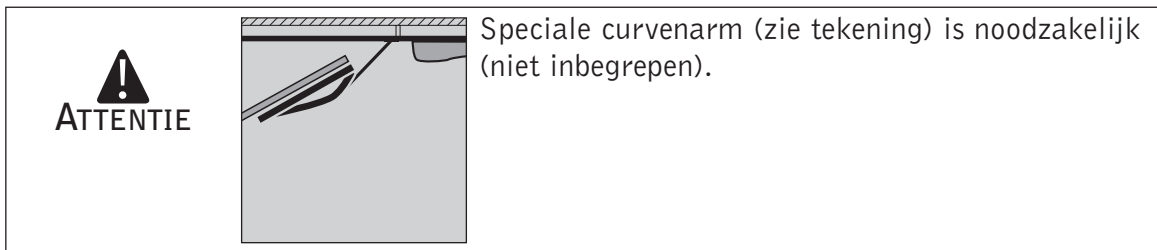
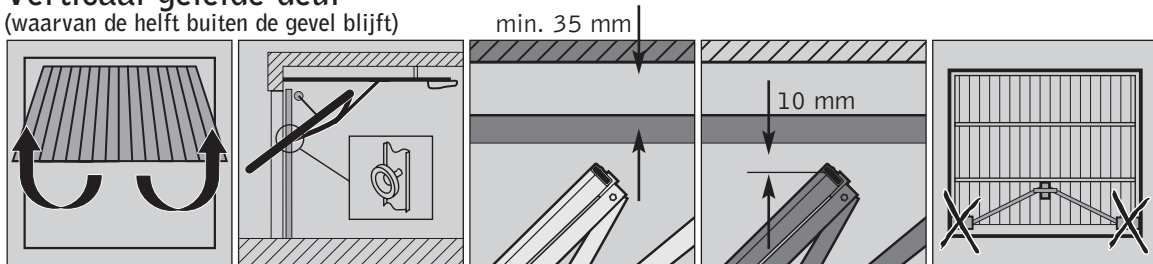

- Bevestig beugel (b) van de rail in het midden boven de deur (op het deurkozijn of op de draagbalk) zodanig dat er minstens 10 mm. afstand is tussen het hoogste punt van de deur en de onderkant van de rail.

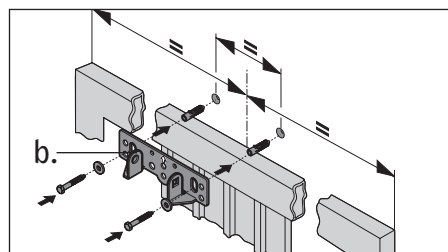

- Monteer de curvenarm volgens de instructies van de leverancier van de arm.
- De aandrijving met behulp van een ondersteuning horizontaal stellen en bevestigen (d).

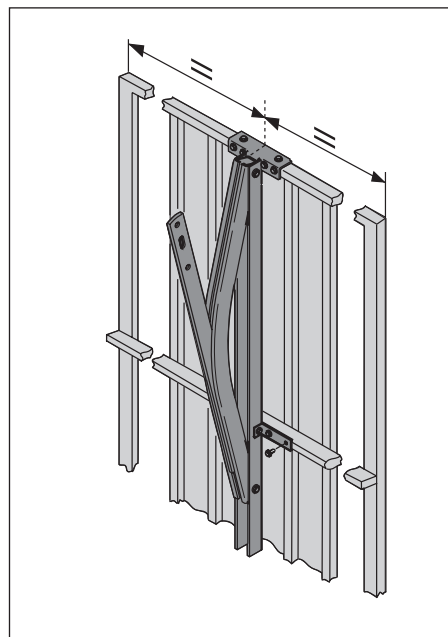
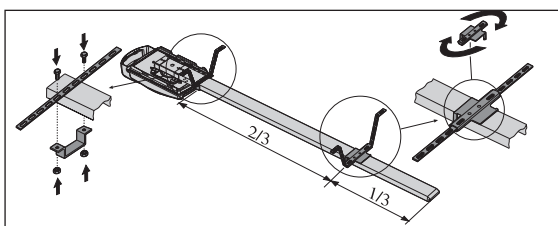
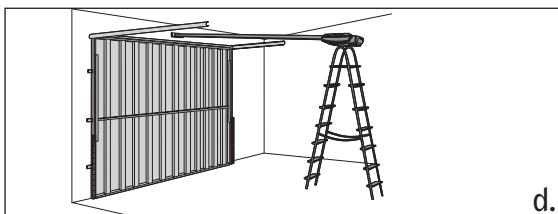

- Ontkoppel loopwagen van ketting of tandriem. Open of sluit de deur langzaam.
- De deur geheel openen en trekstang met curvenarm verbinden. Sluit deur handmatig en controleer of de afstand tussen loopwagen en deur min. 165 mm is.

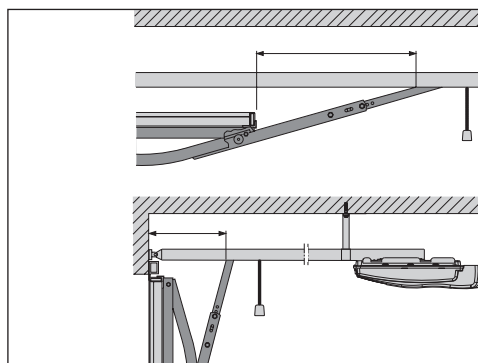









VOOR ALLE OVERIGE DEURTYPEN DIENT U CONTACT OP TE NEMEN MET UW LEVERANCIER!

- 5 Controleer of aandrijving en rail goed geplaatst zijn en alle schroeven zijn aangedraaid. ⚠ Let op: voordat u uw aandrijving gaat programmeren moet uw loopwagen vergrendeld zijn en trekarm aan garagedeur bevestigd zijn.
- 6 Plaats gloeilamp.  
Type E14, max. 40 Watt (niet inbegrepen).



## AANDUIDINGEN ELEKTRONISCH CONTROLEPANEEL

Uw aandrijving heeft een makkelijk controlepaneel met 8 verlichte symbolen en 3 programmeertoetsen.

### LED's

-  externe fotocel
-  deur open
-  automatisch sluiten
-  deur gesloten
-  230V verlichting
-  storing
-  impuls (knippert langzaam indien 'vakantievergrendeling')
-  in bedrijf, netspanning (230V)

### Programmeertoetsen

-  Programmeertoets voor "verminderen" en deur DICHT testtoets
-  Programmeertoets voor "vermeerderen" en deur OPEN testtoets
-  Programmeertoets

### VERKLARING



|                             |   |  |
|-----------------------------|---|--|
| LED uit                     | bijv.    |  |
| LED verlicht                | bijv.    |  |
| LED knippert                | bijv.    |  |
| LED knippert snel           | bijv.    |  |
| Toets ingedrukt             |  of  of  |  |
| Verlichting van aandrijving | aan:  uit:    |  |
| Externe verlichting         | aan:  uit:    |  |



Standaard instelling: bijv.



Nadat aandrijving op netstroom is aangesloten ondergaat hij automatisch een self-test; alle 8 LED's en de gloeilamp zijn voor ongeveer 2 seconden verlicht. De aandrijving is in bedrijfs-toestand nadat de gloeilamp uit is en LED  is verlicht.

### HET MAKEN EN VERANDEREN VAN INSTELLINGEN:

Alle gegevens en veranderingen worden geprogrammeerd met behulp van drie programmeertoetsen. Druk toets  voor ca. 2 sec. in om van bedrijfstoestand naar programmeermode te gaan. Laat toets  los wanneer alle LED's branden en LED  knippert. U bent nu in de programmeermode van de basisfuncties.

Gebruik de  en  toets voor veranderingen in programmeermenu  
 toets om menukeuze / programmering op te slaan in geheugen.

### MENU OVERZICHT:

- ① Programmering van de fotocel
- ② Programmering van deur OPEN eindpositie
- ③ Programmering van deur DICHT eindpositie
- ④ Programmering maximale trekkracht
- ⑤ Programmering maximale duwkracht

### INSTELLEN VAN DE AANDRIJVING:





#### Menu ①

PROGRAMMEREN VAN DE FOTOCEL\* 

1.  toets voor ca. 2 sec indrukken (LED  knippert en alle andere zijn verlicht).
2. A. Druk op  als u een fotocel installeert (LED  verlicht).  
B. Druk op  als u geen fotocel installeert (LED  knippert snel).
3. Druk op  om fotocel functie op te slaan en automatisch naar programmeermenu ② te gaan.  
\*De fotocel is een optionele accessoire.





#### Menu ②

PROGRAMMEREN VAN DE DEUR OPEN EINDPOSITIE 

1. LED  knippert en alle andere zijn verlicht.
2. Druk op de  toets om garagedeur naar gewenste deur OPEN eindpositie te laten gaan. Gebruik de  (OPEN) en  (DICHT) toetsen voor fijnafstelling.
3. Druk op  om deur open eindpositie op te slaan en automatisch naar programmeermenu ③ te gaan.

#### Menu ③





PROGRAMMEREN VAN DE DEUR DICHT EINDPOSITIE 

































































1. LED  knippert en alle andere zijn verlicht.
2. Druk op de  toets om garagedeur naar gewenste deur DICHT eindpositie te laten gaan. Gebruik de  (DICHT) and  (OPEN) toetsen voor fijnafstelling.
3. Druk op  om deur DICHT eindpositie op te slaan en automatisch naar programmeermenu ④ te gaan.

## Menu 4

### PROGRAMMEREN MAXIMALE TREKKRACHT EN

Niettegenstaande de aandrijving een automatisch lerende krachtinstelling heeft raden wij ten eerste aan de maximaal benodigde trekkracht te programmeren. Als de handmatig ingestelde kracht overschreden wordt, zal deze voorrang krijgen op de automatisch geleerde kracht.

1. LED  en LED  knipperen en alle anderen zijn verlicht.
2. Gebruik de  en  toetsen om gewenste kracht in te stellen. Elk verlicht LED is 1/8 van de kracht, dus 1 verlichte LED (1/8) = minimale kracht, alle LED's verlicht (8/8) is maximale kracht.





|   |   |   |   |   |   |   |   |
|---|---|---|---|---|---|---|---|
|  <br> <br> <br> <br>1/8 |  <br> <br> <br> <br>2/8 |  <br> <br> <br> <br>3/8 |  <br> <br> <br> <br>4/8 |  <br> <br> <br> <br>5/8 |  <br> <br> <br> <br>6/8 |  <br> <br> <br> <br>7/8 |  <br> <br> <br> <br>8/8 |
|---|---|---|---|---|---|---|---|

































































3. Druk op  om maximale trekkracht op te slaan en automatisch naar menu 5 te gaan.  
 **Attentie:** Stel uitschakelautomaat zo gevoelig mogelijk in (max. 150 N onderkant van garagedeur).

## Menu 5







### PROGRAMMEREN MAXIMALE DUWKRACHT EN

Niettegenstaande de aandrijving een automatisch lerende krachtinstelling heeft raden wij ten eerste aan de maximaal benodigde trekkracht te programmeren. Als de handmatig ingestelde kracht overschreden wordt, zal deze voorrang krijgen op de automatisch geleerde kracht.

1. LED  en LED  knipperen en alle anderen zijn verlicht.
2. Gebruik de  en  toetsen om gewenste kracht in te stellen.  
Elk verlicht LED is 1/8 van de kracht, dus 1 verlichte LED (1/8) = minimale kracht, alle LED's verlicht (8/8) is maximale kracht.

|   |   |   |   |   |   |   |   |
|---|---|---|---|---|---|---|---|
|  <br> <br> <br> <br>1/8 |  <br> <br> <br> <br>2/8 |  <br> <br> <br> <br>3/8 |  <br> <br> <br> <br>4/8 |  <br> <br> <br> <br>5/8 |  <br> <br> <br> <br>6/8 |  <br> <br> <br> <br>7/8 |  <br> <br> <br> <br>8/8 |
|---|---|---|---|---|---|---|---|

### OPSLAAN VAN INSTELLINGEN:

Druk op  om programmeren van maximale duwkracht op te slaan. Alle LED's gaan in volgorde van LED  tot LED  uit. De aandrijving is nu in bedrijfstoestand (LED  en mogelijk LED  of LED  zijn verlicht).

 **Attentie:** Stel uitschakelautomaat zo gevoelig mogelijk in (max. 150 N onderkant van garagedeur).



**OPMERKING:** Test de gevoeligheid maandelijks en verander, indien noodzakelijk, de instellingen.

### AANSLUITEN VAN DE ONTVANGER:

Ontvanger aansluiten en handzender programmeren volgens de bij de ontvanger geleverde instructies.

### WIJZIGEN VAN DE PROGRAMMATIES:

Programmering van één individueel menu veranderen:

1. Druk ca. 2 seconden op  (LED  knippert en alle andere zijn verlicht).
2. Druk meerdere malen op  totdat het gewenste menu verschijnt (bijv. LED  en LED  knipperen en alle andere LED's zijn verlicht). Van elk 'overgeslagen' menu blijven de instellingen behouden!
3. Volg individuele instructies van het gekozen menu.
4. Druk op  gekozen menu op te slaan en wederom enkele malen om naar bedrijfstoestand terug te keren (LED  en mogelijk LED  of LED  zijn verlicht).

Let op! Als de besturing zich in de programmeermodus bevindt en geen van de drie programmeertoetsen binnen 30 sec. worden ingedrukt, dan wordt het programmeren afgebroken (foutmelding 7).

## Digitaal radiobedieningssysteem met "rolling code"

MAC RC is een radiobedieningssysteem op 433 MHz. Om maximale veiligheid te bieden bestaat het uitgezonden signaal uit een combinatie van een unieke vaste code en een steeds veranderende "rolling code". Dankzij dit systeem beschikt men over meer dan 100.000.000.000.000 verschillende niet-kopieerbare codes.

De leermodus kan geactiveerd worden op de ontvanger of door middel van de zender. Deze tweede mogelijkheid maakt het mogelijk nieuwe zenders in een bestaand systeem te programmeren vanop afstand, wanneer de ontvanger bv. moeilijk bereikbaar is. De gebruikerscode wordt opgeslagen in het EEPROM-geheugen van de ontvanger, die de informatie onthoudt, zelfs bij stroomonderbreking. Het programmeren vanop afstand laat tevens het wissen van een ingeleerde zender toe. De zenders/ontvangers zijn conform de geldende CE-richtlijnen en I-ETS normen. Ze zijn BIPT goedgekeurd.

### 1. Algemeen

De MAC RC-zenders zijn herkenbaar aan hun blauwe drukknoppen. Ze bestaan in drie uitvoeringen: MAC RC 1 (1 kanaal); MAC RC 2 (2 kanalen) en MAC RC 4 (4 kanalen). Alle zenders zijn uitgerust met een batterij-spaarfunctie die de zender uitschakelt wanneer een drukknop langer dan 30 seconden ingedrukt wordt.

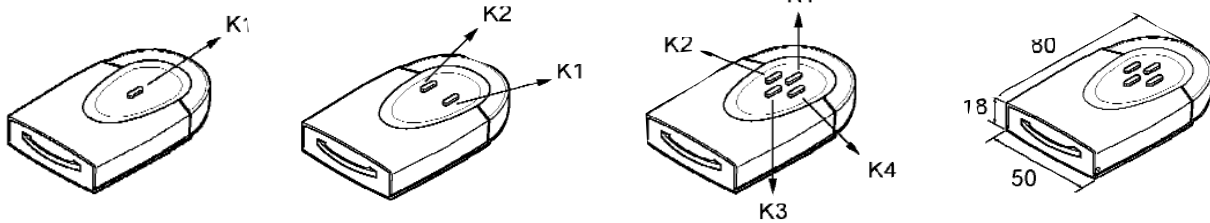

MAC RC 1 (1-kanaalszender)

MAC RC 2 (2-kanaalszender)

MAC RC 4 (4-kanaalszender)

### 2. Programmeren van de zenders

Voor het inleren/wissen d.m.v. de drukknop op de ontvanger verwijzen we naar de handleiding van de ontvanger.

#### 2.1. Openen van de zender en programmeren van de eerste zender

Druk op de MEM-knop. Als de ontvanger continu beeft, drukt u binnen de 5 sec. op de gewenste blauwe kanaalknop. De ontvanger gaat even onderbroken beepen. De zender is nu ingeleerd.

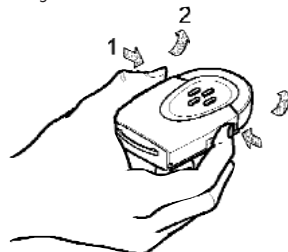

- 1: Indrukken  
2: naar ornhoog duwen

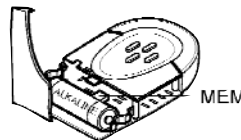

#### OPGELET :

Het inleren van de eerste zender door middel van de zender werkt enkel wanneer het ontvangergeheugen leeg is!

#### 2.2. Programmeren van een bijkomende zender

Druk op de MEM-knop van de reeds aangeleerde zender. Terwijl de ontvanger continu beeft, drukt u binnen de 5 sec. op de reeds aangeleerde knop van de reeds aangeleerde zender. De ontvanger stopt kort met beepen. Vervolgens drukt u op de knop van de nieuw te programmeren zender. De ontvanger gaat even onderbroken beepen. De bijkomende zenderdrukknop is nu ingeleerd.

#### 2.3. Het wissen van een zender uit het geheugen door middel van de zender

Druk binnen de 5 seconden drie maal op de MEM-knop van de reeds ingeleerde zender. Bij de eerste maal gaat de ontvanger continu beepen. Bij de derde maal gaat de ontvanger onderbroken beepen. Druk nu op de knop van het te verwijderen kanaal. De ontvanger stopt onmiddellijk met beepen.

### 3. Technische gegevens

|                                | MAC RC 1                 | MAC RC 2                 | MAC RC 4                 |
|--------------------------------|--------------------------|--------------------------|--------------------------|
| Frequentie                     | 433,92 MHz               | 433,92 MHz               | 433,92 MHz               |
| Voeding                        | 12 V DC batterij GP 23 A | 12 V DC batterij GP 23 A | 12 V DC batterij GP 23 A |
| Uitgezonden vermogen           | -10+7 dBm (100-200mW)    | -10+7 dBm (100-200mW)    | -10+7 dBm (100-200mW)    |
| Opgenomen vermogen bij werking | 28 mA                    | 28 mA                    | 28 mA                    |
| Aantal kanalen                 | 1                        | 2                        | 4                        |
| Werkingstemperatuur            | -10 °C / +55°C           | -10 °C / +55°C           | -10 °C / +55°C           |
| Batterijspaarfunctie           | na 30 seconden           | na 30 seconden           | na 30 seconden           |

De zenders/ontvangers zijn conform de geldende CE-richtlijnen en I-ETS normen. Ze zijn BIPT goedgekeurd.

## 1. Algemeen

De MAC RX 35 is een radio printontvanger op 433,92 MHz compatibel met de MAC RC en de MAC RD handzenders. De RX35 ontvanger is ingebouwd in de MAC TRONIC.

## 2. Het instellen van de ontvanger

**VOOR HET PROGRAMMEREN EN WISSEN DOOR MIDDEL VAN DE ZENDER VERWIJZEN WE NAAR DE HANDLEIDING BIJ DE ZENDER.**

### 2.1. Het aansluiten van de ontvanger

De ontvanger RX 35 is reeds geïnstalleerd in de MAC TRONIC onder de lampkap.

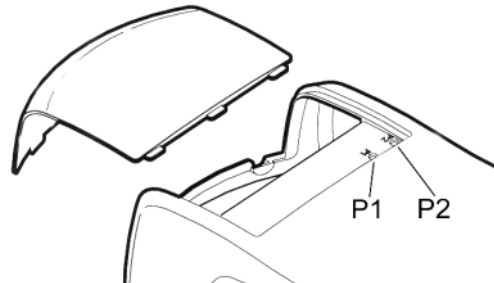

### 2.2. Instelling en programmatie

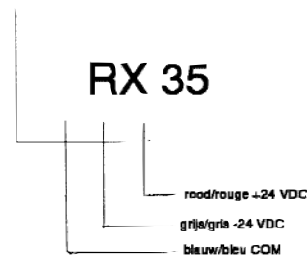
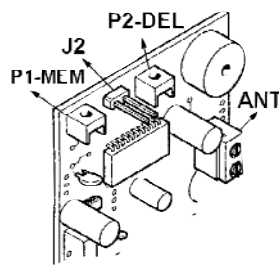

#### P1-MEM = leerknop

- 1) Druk P1 in (blijven indrukken). Na 0,8 sec. zal de zoemer B1 ononderbroken blijven beepen.
- 2) Zend tegelijkertijd het kanaal uit dat moet opgeslagen worden. De zoemer B1 zal met tussenpozen beepen. Herhaal handeling 1) en 2) om een nieuwe code in te voeren.

#### J 2 = keuzebrug

- Polen overbrugd : geschikt voor werking met MAC RD zenders (rood drukknoppen veld)  
 Polen niet overbrugd : geschikt voor werking met MAC RC zenders (blauw drukknoppenveld)

#### P2-DEL = wisknop

##### Wissen van 1 zender:

- 1) Druk P2 in (ingedrukt houden). Na 0,8 sec. gaat de zoemer traag en met tussenpozen beepen.
- 2) Zend het kanaal uit dat moet gewist worden. Zodra de code effectief gewist is, maakt de zoemer een ononderbroken geluid. Herhaal handelingen 1) en 2) om een andere code te wissen.

##### Wissen van alle zenders:

- Druk P2 in (ingedrukt houden). Na 0,8 sec. gaat de zoemer met tussenpozen beepen. Laat nu P2 los en druk binnen de 0,5 sec. opnieuw in; hou min. 10 sec. ingedrukt tot de zoemer ononderbroken beept. Laat nu de toets P2 los.

#### ANT = aansluiting voor antenne

Standaard wordt er een geïsoleerde koperdraad 170 mm. bijgeleverd  
 Bij gebruik van een externe antenne type MAC ANT GP 433 moet de mantel van de RG 58 coax aangesloten worden op de rechtse schroef. De totale coaxlengte mag niet langer zijn dan 10m.

## 3. Technische gegevens

#### Frequentie

#### Geheugen

#### Voeding

#### Max. opgenomen vermogen bij rust

#### Max. opgenomen vermogen tijdens werking

#### Max. belasting relais

#### Werkingsstemp.

#### Impedantie antenne

#### RX 35

433,92 MHz  
 gesoldeerd MEM 85  
 8-12 V DC  
 14mA  
 14mA  
 open collector, 30mA  
 -10°C / +55°C  
 50 W

## EXTERNE AANSLUITINGEN

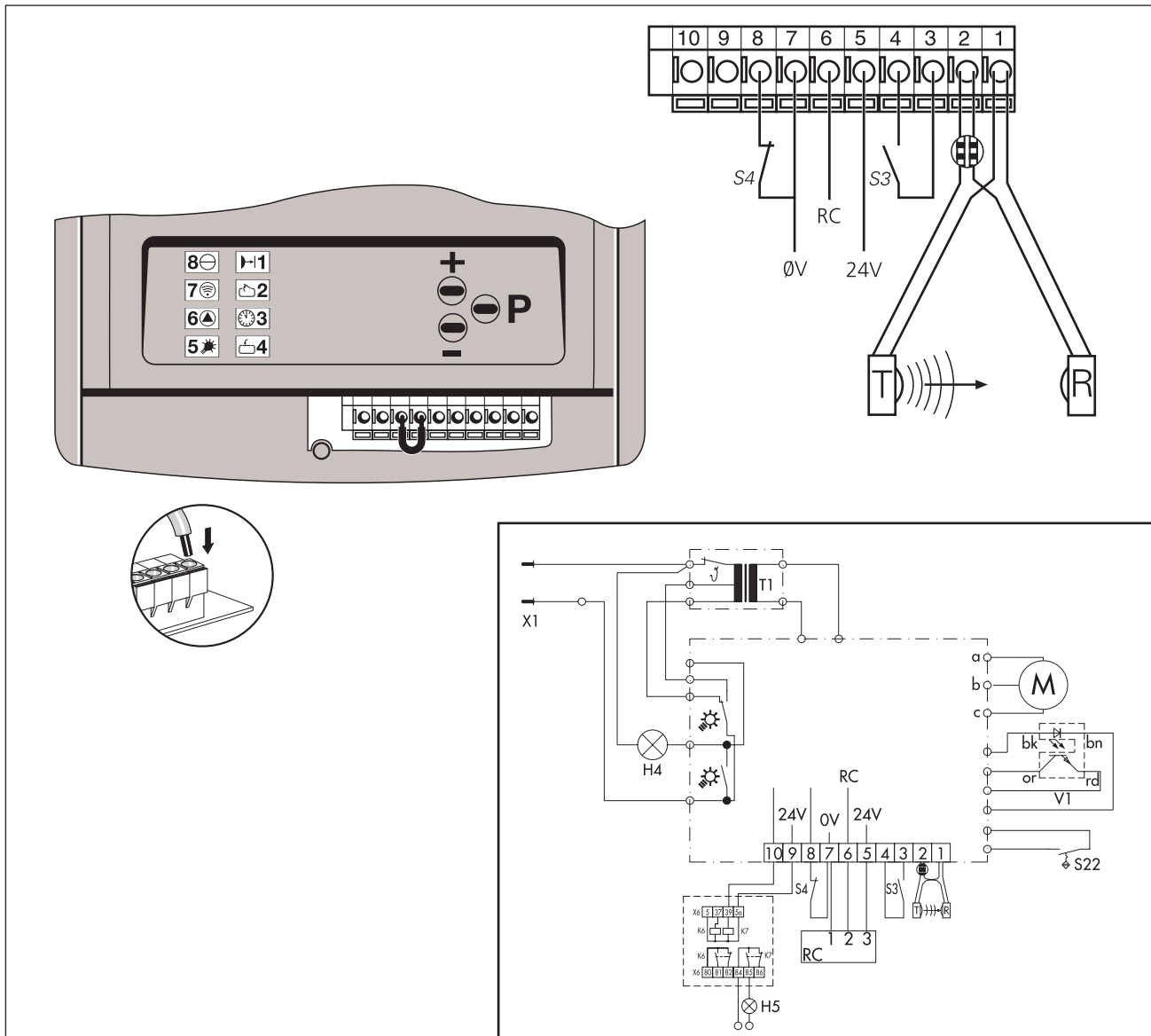

|     |                               |
|-----|-------------------------------|
| M   | motor                         |
| T1  | transformator                 |
| V1  | toerentalsensor (RPM)         |
| S22 | referentiepuntschakelaar      |
| T   | fotocel zender                |
| R   | fotocel ontvanger             |
| S3  | drukknop IMPULSE (NO contact) |
| S4  | drukknop (NC contact)         |
| X1  | plug 1~N 220-240V 50Hz        |
| H4  | gloeilamp                     |
| H5  | signaallamp                   |
| RC  | Relais contact                |
| 0V  | Massa                         |
| 24V | 24 VDC, 50mA max.             |

|    |            |
|----|------------|
| bk | zwart      |
| bn | bruin      |
| or | oranje     |
| rd | rood       |
| a  | bruin      |
| b  | groen/geel |
| c  | groen      |

Het is mogelijk ofwel een druktoets ofwel een 3-voudige wandconsole aan te sluiten (impuls, licht aan/uit, vakantievergrendeling).

Als LED 8 brandt en LED 7 knippert is de vakantievergrendeling geactiveerd.

Deactiveer de vakantievergrendeling via 3-voudige wandconsole of het kort indrukken van de **OP** toets op de aandrijving.



# STORINGSHANDLEIDING

| Storingsindicatie  | Oorzaak  | Werkwijze   |
|--|--|---|
| LED 8 brandt niet.   | Spanning ontbreekt.  | Controleer of netspanning aanwezig is. Wandcontactdoos controleren.   |
|  | Thermische beveiliging transformator is in werking getreden.                 | Transformator laten afkoelen.   |
|  | Besturingseenheid defect.  | Netspanning uitschakelen. Besturingseenheid eraf schroeven en laten controleren.  |
| LED 6 knippert<br>Foutmelding 10   | Uitschakelautomaat te gevoelig.<br>Deur loopt te zwaar of is geblokkeerd.    | Uitschakelautomaat opnieuw instellen (Menu 4, Menu 5). Deur gangbaar maken.   |
| LED 6 knippert<br>Foutmelding 6 of 15  | Externe fotocel defect of onderbroken.                                       | Verwijder belemmering of fotocel laten controleren.   |
| Aandrijving loopt alleen in "OPEN", echter niet in "DICTH" richting.<br>Foutmelding 15 | Fotocel Menu 1 geprogrammeerd, echter niet aangesloten                       | Fotocel omprogrammeren of aansluiten.   |
| Geen reactie na impuls.<br>LED 7 brandt.   | Kortsluiting aan de aansluitklemmen voor drukknop 'impuls'.                  | Alle pulsgevers van de aandrijving loskoppelen. Eén voor één opnieuw aansluiten en fout zoeken.                               |
| Geen reactie na impuls.<br>Foutmelding 36  | Kortsluitstekker S4 (NC) verwijderd, zonder STOP-knop te hebben aangesloten. | Stop-drukknop aansluiten.   |
| Reageert niet op zender maar wel op drukknop<br>LED 8 brandt<br>LED 7 knippert         | Aandrijving is in vakantie-vergrendeling                                     | Deactiveer de vakantievergrendeling via 3-voudige wandconsole of het kort indrukken van de <b>EP</b> toets op de aandrijving. |
| LED 6 knippert<br>Foutmelding 9  | Toerentalsensor defect   | Aandrijving laten nakijken  |
|  | Deur loopt te zwaar  | Deur laten nakijken   |

DIAGNOSE WORDT ZICHTBAAR INDIEN DE **EP** TOETS KORT WORDT INGEDRUKT.

LED knippert onregelmatig

6

7

8

8 + 1

8 + 2

8 + 3

8 + 7

8 + 7 + 1

8 + 7 + 6 + 5 + 2

8 + 7 + 6 + 5 + 1

8 + 7 + 6 + 5 + 4 + 3 + 2 + 1

Foutmelding

6

7

8

9

10

11

15

16

28

27

36

Storingsindicatie

Fotocel onderbroken

Programmering afgebroken

Referentiepuntschakelaar defect

Toerentalsensor defect  
Blokkeerbeveiliging aangesproken

Krachtbegrenzing

Looptijdbegrenzing

Test fotocel niet o.k.

Test krachtbegrenzing

Zelflerende krachtbegrenzing

'Meerwaarde' gevoeligheid krachtbegrenzing

Ruststroomcircuit onderbroken

## PROGRAMMEREN VAN DE BESTURING - GEAVANCEERDE INSTELLINGEN

Waarschuwing – Het programmeren van de geavanceerde instellingen mag alleen door een getraind en bevoegd vakman worden uitgevoerd.

### GEAVANCEERDE PROGRAMMEER EN UITBREIDINGSMOGELIJKHEDEN:

- Automatisch sluiten (Niveau 3).
- Aanpassen Automatische krachtinstellingen en verlichting (Niveau 4).
- Verlichting / signaallampen (Niveau 5).

## PROGRAMMEREN VAN DE BESTURING - AUTOMATISCH SLUITEN (NIVEAU 3)

Waarschuwing – Bij activering van de functie automatisch sluiten moet een fotocel aangesloten worden overeenkomstig Menu ① in de basisfuncties.

### MENU OVERZICHT (N3):

- ① Tijdsduur 'deur open' (automatisch sluiten).
- ② Programmeren voorwaarschuwingstijd (tijd voordat de deur sluit).
- ③ Programmeren voorwaarschuwingstijd voordat de deur opengaat  
(te gebruiken in combi met waarschuwingslamp).
- ④ Voortijdig sluiten na het passeren van de fotocel.
- ⑤ Reset van de niveau 3 menu's

### PROGRAMMEREN AUTOMATISCH SLUITEN:

Menu ① (N3)

TIJDSDUUR 'DEUR OPEN' (AUTOMATISCH SLUITEN)

Besturing bevindt zich in bedrijfstoestand.

1. Programmeertoetsen , en tegelijk ca. 10 seconden indrukken totdat LED knippert en alle andere zijn verlicht.
2. Laat los (LED knippert).
3. Gebruik de en toetsen om 'deur open' tijdsduur te programmeren.  
minimale tijd: 5 seconden  
maximale tijd: 255 seconden



|             |         |         |         |         |         |         |         |         |         |         |         |         |         |         |         |  |  |  |
|-------------|---------|---------|---------|---------|---------|---------|---------|---------|---------|---------|---------|---------|---------|---------|---------|--|--|--|
|             |         |         |         |         |         |         |         |         |         |         |         |         |         |         |         |  |  |  |
| timer       | 5       | 10      | 15      | 20      | 25      | 30      | 35      | 40      | 50      | 80      | 100     | 120     | 150     | 180     | 255     |  |  |  |
| deactivated | seconds | seconds | seconds | seconds | seconds | seconds | seconds | seconds | seconds | seconds | seconds | seconds | seconds | seconds | seconds |  |  |  |

























































































































4. Druk op om 'deur open' tijdsduur op te slaan en automatisch naar Menu ② te gaan.

## Menu 2 (N3)

### PROGRAMMEREN VOORWAARSCHUWINGSTIJD (TIJD VOORDAT DEUR SLUIT)

Nadat de 'deur open' tijdsduur is geprogrammeerd knippert LED .



- Controleer of LED  knippert en dat alle andere zijn verlicht.
- Gebruik de  en  toetsen om 'voorwaarschuwingstijd' te programmeren.  
minimale tijd: 2 seconden  
maximale tijd: 70 seconden









































































































|   |   |   |   |   |   |   |   |  |  |  |   |   |   |   |               |
|---|---|---|---|---|---|---|---|--|--|--|---|---|---|---|---------------|
|         |         |         |         |         |         |         |         |         |         |         |         |         |         |         |               |
| timer<br>deactivated  | 2<br>seconds  | 5<br>seconds  | 10<br>seconds   | 15<br>seconds   | 20<br>seconds   | 25<br>seconds   | 30<br>seconds   | 35<br>seconds  | 40<br>seconds  | 45<br>seconds  | 50<br>seconds   | 55<br>seconds   | 60<br>seconds   | 65<br>seconds   | 70<br>seconds |

- Druk op  om op te slaan en naar Menu  te gaan.

## Menu 3 (N3)

### PROGRAMMEREN VOORWAARSCHUWINGSTIJD VOORDAT DE DEUR OPENGAAT





- Controleer of LED  knippert en dat alle andere zijn verlicht.
- Gebruik de  en  toetsen om 'voorwaarschuwingstijd' te programmeren.  
minimale tijd: 0 seconden  
maximale tijd: 7 seconden





|   |   |   |   |   |   |   |  |  |  |   |   |   |
|---|---|---|---|---|---|---|--|--|--|---|---|---|
|         |         |         |         |         |         |         |         |         |         |         |         |         |
| 0 seconds   | 1 seconds   | 2 seconds   | 3 seconds   | 4 seconds   | 5 seconds   | 6 seconds   | 7 seconds  |  |  |   |   |   |

- Druk op  om op te slaan en naar Menu  te gaan.





## Menu 4 (N3)

### VOORTIJDIG SLUITEN NA HET PASSEREN VAN DE FOTOCCEL

- Controleer of LED  knippert en dat alle andere zijn verlicht.
- Gebruik de  en  toetsen om de gewenste instelling te kiezen:
  - LED  knippert: Deur sluit na de ingestelde tijd
  - LED  brandt: Deur sluit na het passeren van de fotocel

|   |   |
|---|---|
|         |      |
| Deur sluit na de ingestelde tijd  | Deur sluit na het passeren van de fotocel   |

- Druk op  om op te slaan en om het geavanceerde programmeerniveau 3 "Automatisch sluiten" te beëindigen.

Alle LED's gaan in volgorde van  tot  uit. De aandrijving is nu in bedrijfstoestand; LED  en mogelijk LED  (deur volledig open) of LED  (deur volledig gesloten) zijn verlicht.

## Menu 5 (N3)

### RESET VAN DE NIVEAU 3 MENU'S:

Druk de programmeertoetsen en tegelijk in voor langer dan 20 seconden.

De reset is uitgevoerd wanneer de LED's automatisch uitschakelen beginnende met LED en eindigend met LED .

De aandrijving is nu terug in bedrijfstoestand; LED en mogelijk LED (deur volledig open) of LED (deur volledig gesloten) zijn verlicht.

## PROGRAMMEREN AUTOMATISCHE KRACHTINSTELLINGEN EN VERLICHTING (N4)

Waarschuwing – Het programmeren van de geavanceerde instellingen mag alleen door een getraind en bevoegd vakman worden uitgevoerd.

### MENU OVERZICHT (N4):

- 1 Programmeren tijdsduur verlichting
- 2 Programmeren 'meerwaarde' automatisch geleerde kracht
- 3 Programmeren van 'meerwaarde' automatisch geleerde kracht in langzame snelheid

### HET AANPASSEN VAN DE AUTOMATISCHE KRACHTINSTELLINGEN EN VERLICHTING:

1. Druk in de bedrijfstoestand tegelijk ca. 10 seconden op , en totdat LED knippert en alle andere LED's zijn verlicht.
2. Blijf op drukken en selecteer met de of toets Niveau 4 (LED knippert snel).
3. Laat los.

### Menu 1 (N4)

#### PROGRAMMEREN TIJDSDUUR VERLICHTING (💡)

1. LED knippert en alle andere zijn verlicht.
2. Gebruik de of toetsen om verlichtingsduur te programmeren.  
minimale tijd: 90 seconden  
maximale tijd: 240 seconden

|         |         |         |         |         |         |         |         |         |         |         |         |         |         |         |         |
|---------|---------|---------|---------|---------|---------|---------|---------|---------|---------|---------|---------|---------|---------|---------|---------|
|         |         |         |         |         |         |         |         |         |         |         |         |         |         |         |         |
|         |         |         |         |         |         |         |         |         |         |         |         |         |         |         |         |
|         |         |         |         |         |         |         |         |         |         |         |         |         |         |         |         |
|         |         |         |         |         |         |         |         |         |         |         |         |         |         |         |         |
| 90      | 95      | 100     | 110     | 120     | 130     | 140     | 150     | 160     | 170     | 180     | 190     | 200     | 210     | 220     | 240     |
| seconds | seconds | seconds | seconds | seconds | seconds | seconds | seconds | seconds | seconds | seconds | seconds | seconds | seconds | seconds | seconds |

3. Druk op om op te slaan en automatisch naar Menu 2 te gaan.

### Menu 2 (N4)

#### PROGRAMMEREN 'MEERWAARDE' AUTOMATISCH GELEERDE KRACHT

1. LED knippert en alle andere zijn verlicht.
2. Gebruik de of toetsen om 'meerwaarde' in stappen van 1/15 te verhogen of te verminderen.  
minimale meerwaarde: 1/15  
maximale meerwaarde: 15/15

|                  |      |      |      |      |      |      |      |      |      |       |       |       |       |       |       |
|------------------|------|------|------|------|------|------|------|------|------|-------|-------|-------|-------|-------|-------|
|                  |      |      |      |      |      |      |      |      |      |       |       |       |       |       |       |
|                  |      |      |      |      |      |      |      |      |      |       |       |       |       |       |       |
|                  |      |      |      |      |      |      |      |      |      |       |       |       |       |       |       |
|                  |      |      |      |      |      |      |      |      |      |       |       |       |       |       |       |
| deakti-<br>vated | 1/15 | 2/15 | 3/15 | 4/15 | 5/15 | 6/15 | 7/15 | 8/15 | 9/15 | 10/15 | 11/15 | 12/15 | 13/15 | 14/15 | 15/15 |

3. Druk op om op te slaan en automatisch naar Menu 3 te gaan.

### Menu 3 (N4)

#### PROGRAMMEREN VAN 'MEERWAARDE' AUTOMATISCH GELEERDE KRACHT IN LANGZAME SNELHEID

- LED knippert en alle andere zijn verlicht.
- Gebruik de of toetsen om 'meerwaarde' automatisch geleerde kracht in langzame snelheid in stappen van 1/15 te verhogen of te verminderen.

minimale meerwaarde: 1/15  
maximale meerwaarde: 15/15

|                  |      |      |      |      |      |      |      |      |      |       |       |       |       |       |       |  |  |
|------------------|------|------|------|------|------|------|------|------|------|-------|-------|-------|-------|-------|-------|--|--|
|                  |      |      |      |      |      |      |      |      |      |       |       |       |       |       |       |  |  |
|                  |      |      |      |      |      |      |      |      |      |       |       |       |       |       |       |  |  |
|                  |      |      |      |      |      |      |      |      |      |       |       |       |       |       |       |  |  |
|                  |      |      |      |      |      |      |      |      |      |       |       |       |       |       |       |  |  |
| deakti-<br>vated | 1/15 | 2/15 | 3/15 | 4/15 | 5/15 | 6/15 | 7/15 | 8/15 | 9/15 | 10/15 | 11/15 | 12/15 | 13/15 | 14/15 | 15/15 |  |  |

- Druk op om op te slaan en om het geavanceerde programmeerniveau 4 "Automatische krachtinstellingen en verlichting " te beëindigen.

Alle LED's gaan in volgorde van tot uit. De aandrijving is nu in bedrijfstoestand; LED en mogelijk LED (deur volledig open) of LED (deur volledig gesloten) zijn verlicht.

## PROGRAMMEREN VAN VERLICHTING / SIGNAALLAMPEN (NIVEAU 5)

Waarschuwing - Het programmeren van de geavanceerde instellingen mag alleen door een getraind en bevoegd vakman worden uitgevoerd.

### MENU OVERZICHT (N5):

- 1 Programmeren van looptijdbe grenzing
- 2 Programmeren van externe signaal lampen
- 3 Programmeren van verlichting van de aandrijving
- 4 Programmeren verlichting 'externe lichtrelais' (box) en van de aandrijving

### HET AANPASSEN VAN DE VERLICHTING EN/OF SIGNAALLAMPEN:

- Druk in de bedrijfstoestand tegelijk ca. 10 seconden op , en totdat LED knippert en alle andere LED's zijn verlicht.
- Blijf op drukken en selecteer met de of toets Niveau 5 (LED knippert snel)
- Laat los.

### Menu 1 (N5)

#### PROGRAMMEREN VAN LOOPTIJD BEGRENZING (MAXIMALE DUUR VAN SLUITEN)

- LED knippert en alle andere zijn verlicht.
- Gebruik de en toetsen om verlichtingsduur te programmeren  
minimale tijd: 30 seconden  
maximale tijd: 240 seconden

|               |               |               |               |               |               |                |                |                |                |                |                |                |                |                |                |  |  |
|---------------|---------------|---------------|---------------|---------------|---------------|----------------|----------------|----------------|----------------|----------------|----------------|----------------|----------------|----------------|----------------|--|--|
|               |               |               |               |               |               |                |                |                |                |                |                |                |                |                |                |  |  |
|               |               |               |               |               |               |                |                |                |                |                |                |                |                |                |                |  |  |
|               |               |               |               |               |               |                |                |                |                |                |                |                |                |                |                |  |  |
|               |               |               |               |               |               |                |                |                |                |                |                |                |                |                |                |  |  |
| 30<br>seconds | 40<br>seconds | 50<br>seconds | 55<br>seconds | 65<br>seconds | 80<br>seconds | 100<br>seconds | 120<br>seconds | 140<br>seconds | 160<br>seconds | 180<br>seconds | 190<br>seconds | 200<br>seconds | 210<br>seconds | 220<br>seconds | 240<br>seconds |  |  |

- Druk op om op te slaan en automatisch naar Menu 2 te gaan.

## Menu ② (N5)

### PROGRAMMEREN VAN EXTERNE SIGNAALLAMPEN (🔦/🚪)

1. LED 🚪2 knippert en alle andere zijn verlicht.
2. Gebruik de ⬆️ en ⬇️ toetsen voor het programmeren van verlichting  
LED 🚪1 knippert                      externe lampen branden  
LED 🚪1 brandt                          externe lampen knipperen

|  |  |
|--|--|
| 8🚪 🚪1<br>7🚪 🚪2<br>6🚪 🚪3<br>5🚪 🚪4<br>externe lampen branden | 8🚪 🚪1<br>7🚪 🚪2<br>6🚪 🚪3<br>5🚪 🚪4<br>externe lampen knipperen |
|--|--|

3. Druk op 🚪P om op te slaan en automatisch naar Menu ③ te gaan.

## Menu ③ (N5)

### PROGRAMMEREN VAN VERLICHTING VAN DE AANDRIJVING (💡/💡)

1. LED 🚪3 knippert en alle andere zijn verlicht.
2. Gebruik de ⬆️ en ⬇️ toetsen voor het programmeren van verlichting  
LED 🚪1 knippert                      verlichting brandt tijdens voorwaarschuwingstijd (sluiten)  
LED 🚪1 brandt                          verlichting knippert tijdens voorwaarschuwingstijd (sluiten)

|  |  |
|--|--|
| 8🚪 🚪1<br>7🚪 🚪2<br>6🚪 🚪3<br>5🚪 🚪4<br>verlichting brandt tijdens waarschuwingstijd | 8🚪 🚪1<br>7🚪 🚪2<br>6🚪 🚪3<br>5🚪 🚪4<br>verlichting knippert tijdens waarschuwingstijd |
|--|--|

3. Druk op 🚪P om op te slaan en automatisch naar Menu ④ te gaan.

## Menu ④ (N5)

### PROGRAMMEREN VERLICHTING 'EXTERNE LICHTRELAIS' (BOX) EN VAN DE AANDRIJVING

1. LED 🚪4 knippert en alle andere zijn verlicht.
2. Gebruik de ⬆️ en ⬇️ toetsen voor het programmeren van verlichting  
LED 🚪1 knippert                      aandrijvingverlichting brandt tijdens waarschuwingstijd  
LED 🚪1 brandt                          extern lichtrelais 30 sec. alarmmelding na het aanspreken  
van de beveiliging tegen ongewenst openen.

|   |   |
|---|---|
| 8🚪 🚪1<br>7🚪 🚪2<br>6🚪 🚪3<br>5🚪 🚪4<br>aandrijvingverlichting brandt tijdens waarschuwingstijd | 8🚪 🚪1<br>7🚪 🚪2<br>6🚪 🚪3<br>5🚪 🚪4<br>extern lichtrelais 30 sec. alarmmelding na het aanspreken<br>van de beveiliging tegen ongewenst openen. |
|---|---|

3. Druk op 🚪P om op te slaan en om het geavanceerde programmeerniveau 5 " Programmeren van Verlichting / signaallampen " te beëindigen.

Alle LED's gaan in volgorde van LED 8🚪 tot LED 🚪1 uit. De aandrijving is nu in bedrijfs-toestand; LED 8🚪 en mogelijk LED 🚪2 (deur volledig open) of LED 🚪4 (deur volledig gesloten) zijn verlicht.

## TECHNISCHE GEGEVENS:

**MAC Tronic 100**  
Garagedeuropener

**Aansluiting**

230 V  
250 W (in bedrijf met verlichting)  
3,9 W (stilstand zonder verlichting)

**Bewegingssnelheid:**

0,14 m/sec. met softstart en softstop

**Trek- en duwkracht:**

1000 N

**Looptijdbegrenzing:**

88 sec. (instelbaar)

**Verlichting:**

1 x 40 W (type E14), instelbaar van  
90 - 240 sec.

**Tension du circuit de commande:**

Laagspanning minder dan 24 V DC

**Automatisch sluiten:**

Voor het automatisch sluiten van garagedeur zijn de optionele fotocellen noodzakelijk. Waarschuwingstijd instelbaar van 2 tot 70 sec. en openingstijd van 5 - 255 sec. Voor aansluiting signaallampen is een extern lichtrelais als toebehoren verkrijgbaar.

**Uitschakelautomaat:**

Elektronische krachtbegrenzing door microprocessor en stroomsensor.

**Blokkeerbeveiliging:**

Door microprocessor en toerentalsensor.

**Inbraak beveiligingssysteem:**

Elektronische back-drive beveiliging bij gesloten deur; deur sluit zich automatisch na detectie van een circa 1cm. ongewenste (terugwaartse) beweging.

**Beschermingsgraad:**

Uitsluitend geschikt voor droge ruimtes.

**⚠ Let op:** Plaatselijke veiligheidsvoorschriften in acht nemen!  
Netvoeding- en stroomleidingen absoluut gescheiden leggen.

**⚠ Let op:** Open en sluit de deur alleen als deze volledig zichtbaar is en wanneer u er zeker van bent dat er zich geen personen of objecten in het looptraject van garagedeur bevinden.

### Onderhoud

Deze garagedeuropener is grotendeels onderhoudsvrij. Echter, alle bewegende delen van de deur en de aandrijving dienen regelmatig gecontroleerd en goed afgesteld te worden. Controleer regelmatig manueel of de deur vlot loopt en goed uitgebalanceerd is. De instelling van uitschakelautomaat OPEN en DICT dient regelmatig getest te worden.

**⚠ CONSIGNES DE SECURITE IMPORTANT POUR L'INSTALLATION**  
**AVERTISSEMENT - UNE INSTALLATION INCORRECTE PEUT CAUSER DE GRAVES BLESSURES. LISEZ CES INSTRUCTIONS ATTENTIVEMENT AVANT D'INSTALLER L'ENTRAÎNEMENT.**

Vérifiez si la porte de garage est bien équilibrée et si elle s'ouvre et se referme facilement avant que vous installiez l'entraînement.

- N'utilisez pas de contrepoids supplémentaires pour compenser le fait que la porte ne marche pas bien. Des contrepoids excessifs peuvent gêner le Système d'Inversion ou peuvent endommager la porte.
- Enlevez tous les câbles, leviers, crochets, brides et autres saillies auxquels vous risquez d'être accrochés. Ne portez pas de vêtements amples.
- Installez le bouton-poussoir tout près de la porte, mais hors d'atteinte des pièces mobiles. Il est conseillé d'installer le bouton-poussoir assez haut, hors d'atteinte des enfants.
- Le test du **Système d'Inversion** est très important. Une porte qui se ferme doit s'arrêter et se réouvrir quand il y a un obstacle sous la porte. Un réglage incorrecte peut causer des dommages ou des blessures. Faites ce test tous les mois et adaptez les réglages si nécessaire (voir menu ④ et menu ⑤ à la page 35 de ce manuel).

Tenez compte des consignes locales de sécurité.

Pour éviter des phénomènes d'induction, il est impératif de séparer dans des gaines différentes les câbles de basse tension (bouton-poussoir, cellule photo-électrique,...) et ceux de l'alimentation.

- S'il n'y pas un deuxième accès au garage, il faut installer un déverrouillage de secours à l'extérieur. Cet accessoire doit permettre l'accès au garage lors d'une interruption de courant.
- Débranchez l'entraînement avant d'ouvrir le boîtier!
- Vérifiez régulièrement si l'installation (notamment les câbles, ressorts et fixations) est encore en bon état et si la porte est toujours bien équilibrée. Ne travaillez jamais vous-même à la porte, aux ressorts ou aux câbles; une porte que n'est pas bien équilibrée peut causer des blessures.
- Démontez tous les serrures et les verrouillages de la porte ou mettez-les hors d'usage.

**REMARQUE IMPORTANTE POUR LA SECURITE**

Tenez les gens et les animaux à distance des portes en mouvement. Montrez à tout le monde comment il faut utiliser l'entraînement en sécurité. Ne donnez une commande d'ouverture ou de fermeture que lorsque la porte est à portée de vue. Veillez à ce que des enfants ne jouent pas avec la porte ou les télécommandes.



Gardez ce manuel en vue de futurs entretiens, réglages et réparations.

## INTRODUCTION

Nous vous félicitons de l'achat de votre nouvel ouvre-porte. Cet entraînement est le résultat d'une conception méticuleuse et de précises techniques de production. Tous nos produits sont testés à l'usine et garantissent une qualité et une sécurité optimales.

Conformez-vous aux instructions dans ce manuel afin d'éviter des dommages à l'entraînement ou à la porte de garage et afin de répondre aux directives des machines.

### CONTENU

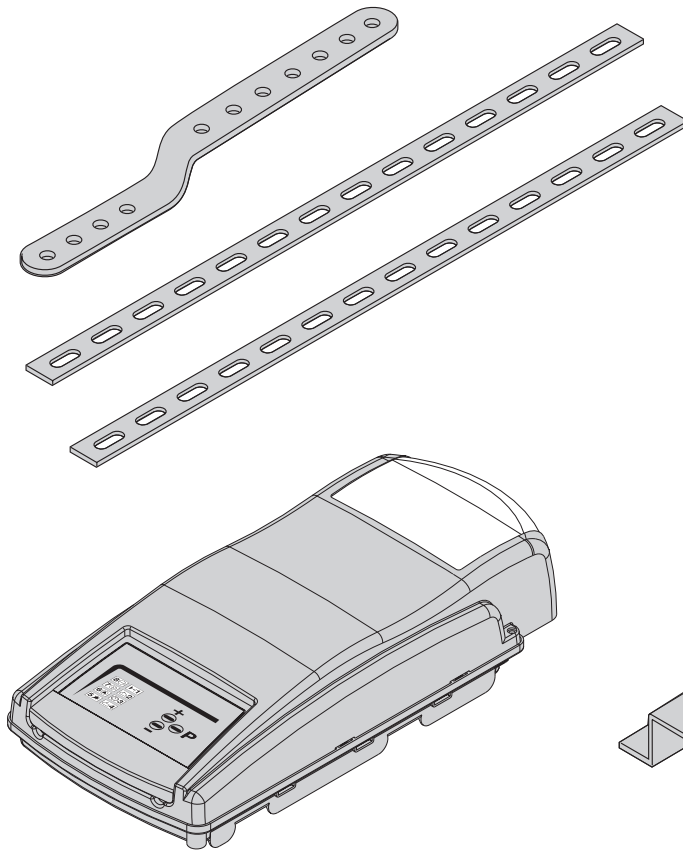

Le rail est livré séparément.

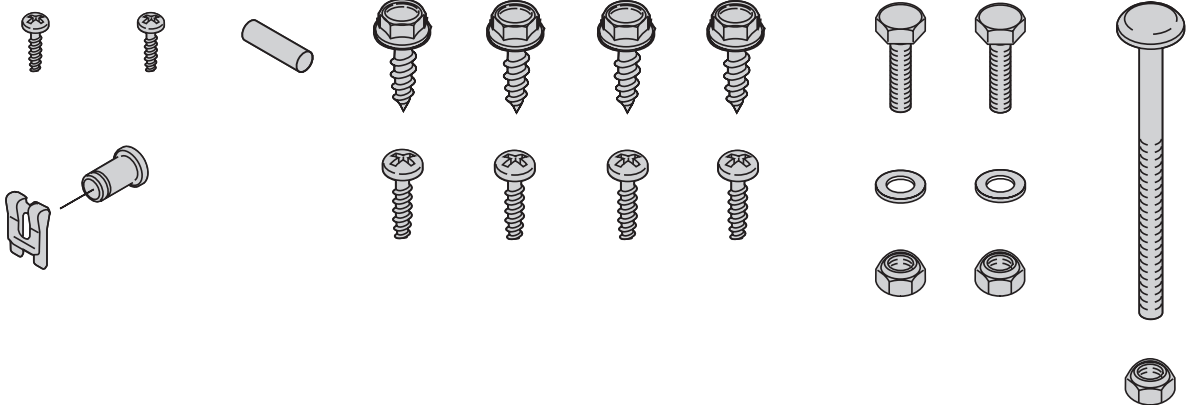
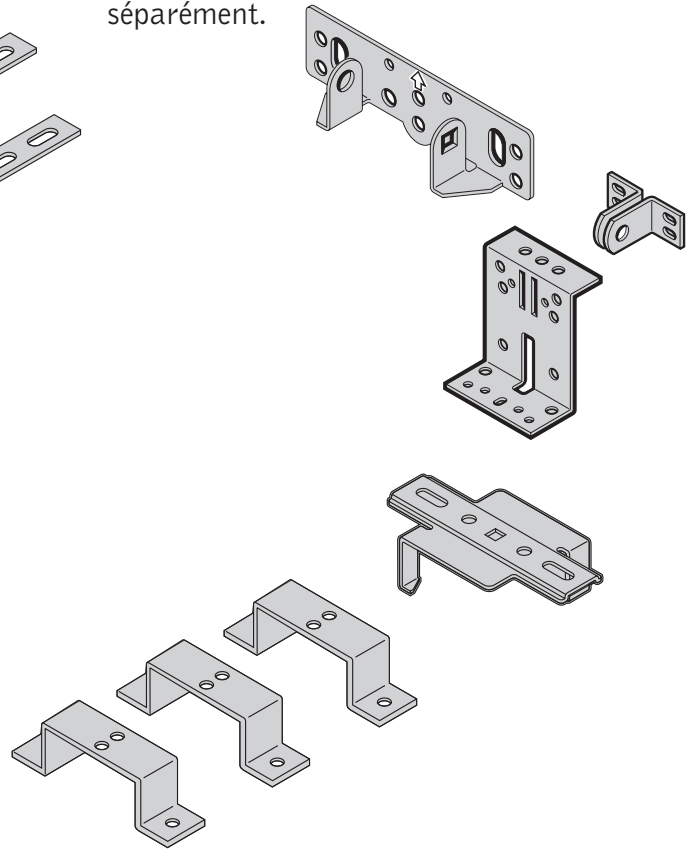

## DISPOSITIFS DE SECURITE

- **Réouverture automatique**  
Une porte fermante s'arrête et se réouvre automatiquement endéans les 2 secondes quand la porte rencontre un obstacle.
- **Limitation automatique de la durée de fonctionnement**  
La porte fermante s'arrête et se réouvre si elle ne s'est pas entièrement fermée endéans les 88 secondes (réglable 30 - 240 secondes).
- **Arrêt de sécurité**  
La porte ouvrante s'arrête endéans les 2 secondes quand elle rencontre un obstacle.
- **Cellule photo-électrique**  
Nous vous conseillons d'installer une cellule photo-électrique comme sécurité supplémentaire. Quand un objet ou une personne coupe le rayon infrarouge pendant la fermeture, la porte s'arrête et se réouvre sans que personne n'ait touché à la porte.

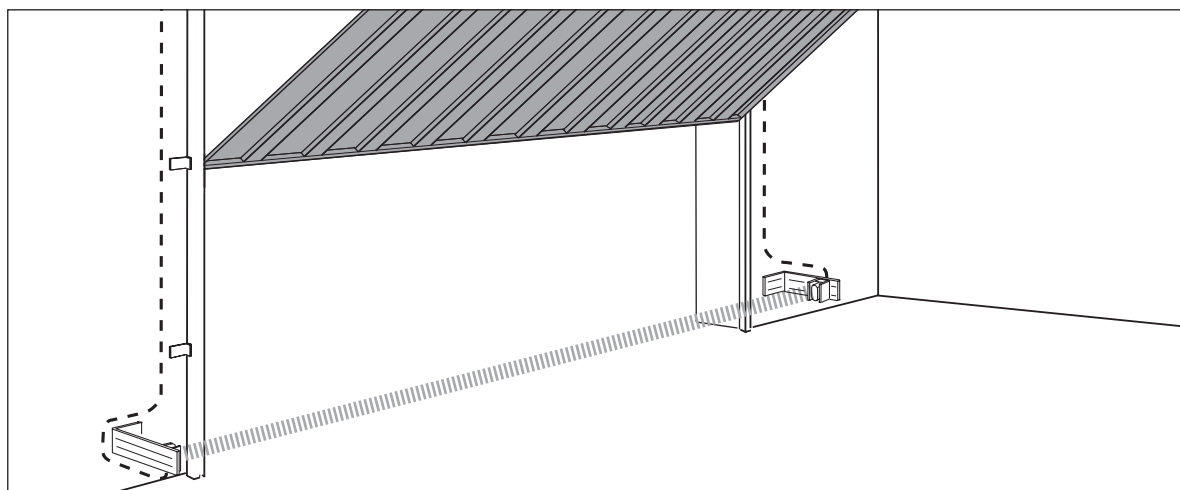

## IMPORTANT

Afin de garantir une sécurité optimale il faut programmer la limitation de force indépendante en ouverture et en fermeture (voir menu ④ et ⑤ à la page 35 de ce manuel), et vérifier les réglages régulièrement.

## INSTRUCTIONS POUR LE MONTAGE

**Attention:** lorsque l'entraînement est livré avec un rail en deux pièces, il faut suivre les instructions de montage livré avec le rail.

### 1 Fixez le rail à l'entraînement à l'aide des 2 étriers.

Faites attention à ce que les vis soient bien serrés.

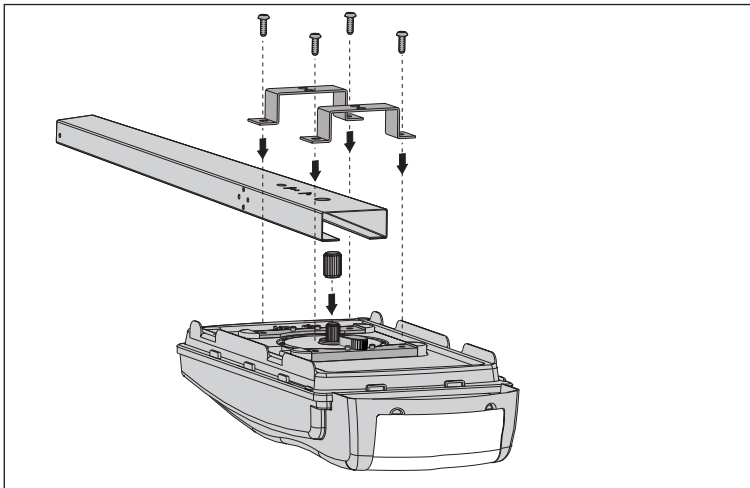

### 2 Montez le levier de verrouillage et la barre de traction sur le chariot.

- Retirez le levier de sa position de transport et positionnez dans la place prévue sur le chariot. (fig. 1)
- Vissez le bras de connexion dans le chariot. Faites attention à la position du cordon de trage (fig. 2) afin d'éviter des dégâts et un fonctionnement incorrect.

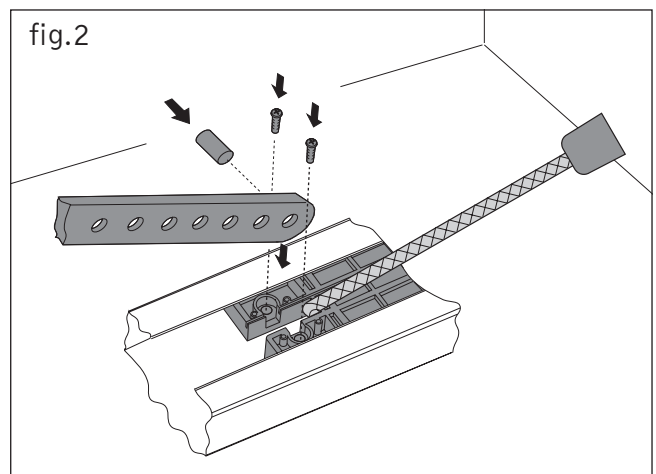
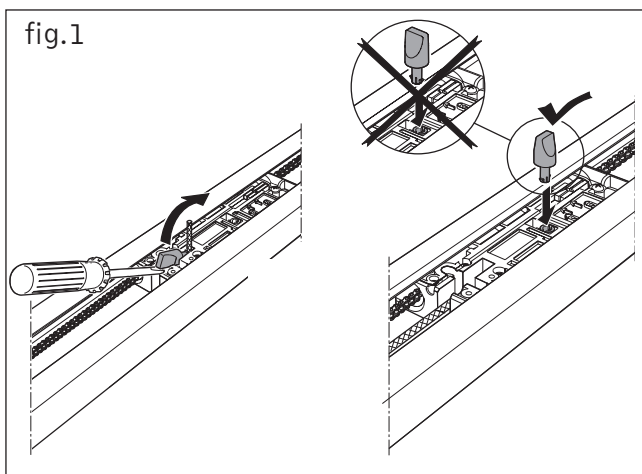

### 3 Déverrouillage

- a. Pour déverrouiller le chariot: tirez la corde "a". Le chariot reste déverrouillé (fig 3.)
- b. Pour remettre le chariot en marche: bougez le levier rouge dans le sens de la flèche et démarrez l'ouvre-porte. (fig. 4).

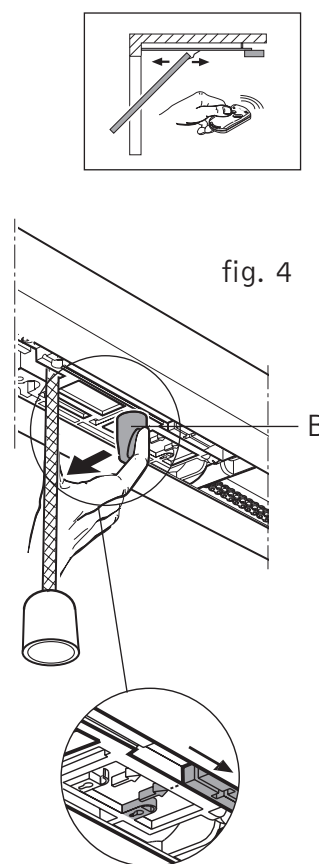
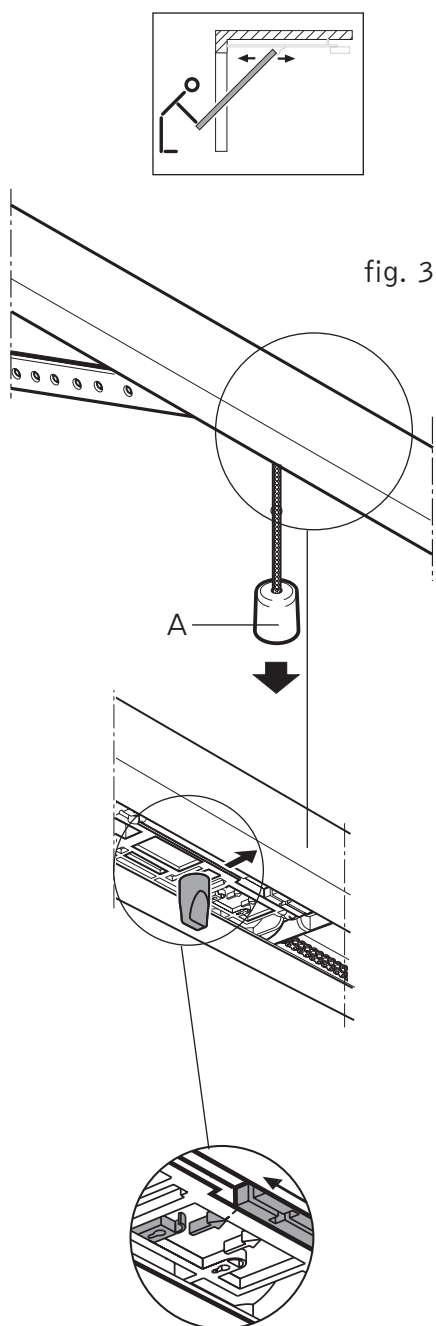

## INSTRUCTIONS D'INSTALLATION

### DÉTERMINEZ LE TYPE DE PORTE DE GARAGE

Vérifiez avant l'installation de l'entraînement si l'opérateur convient pour la porte que vous avez. Déterminez le type de votre porte dans les chapitres 4A, 4B, 4C ou 4D et suivez les instructions individuelles scrupuleusement. Contactez votre fournisseur pour tout autre type de porte. Des accessoires spéciales ou des adaptations peuvent être nécessaires.

#### 4A Portes débordantes

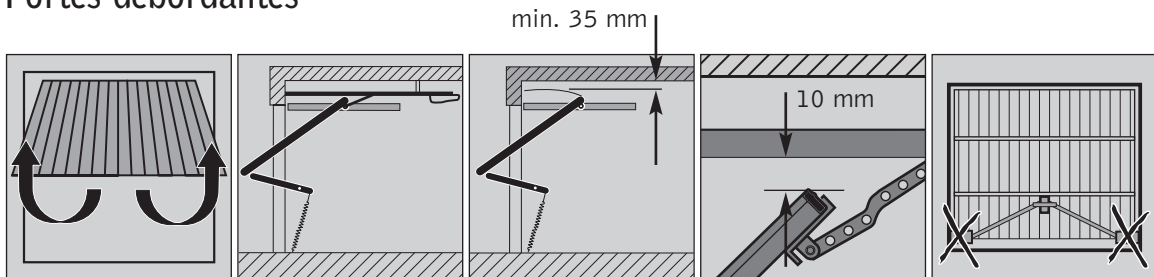

- Montez la patte (a) au milieu de la porte. Fixez l'étrier (b) du rail au-dessus de la porte, sur le dormant ou sur la poutre, de telle façon qu'il y a minimum 10 mm de jeu entre la partie la plus haute de la porte et le rail.

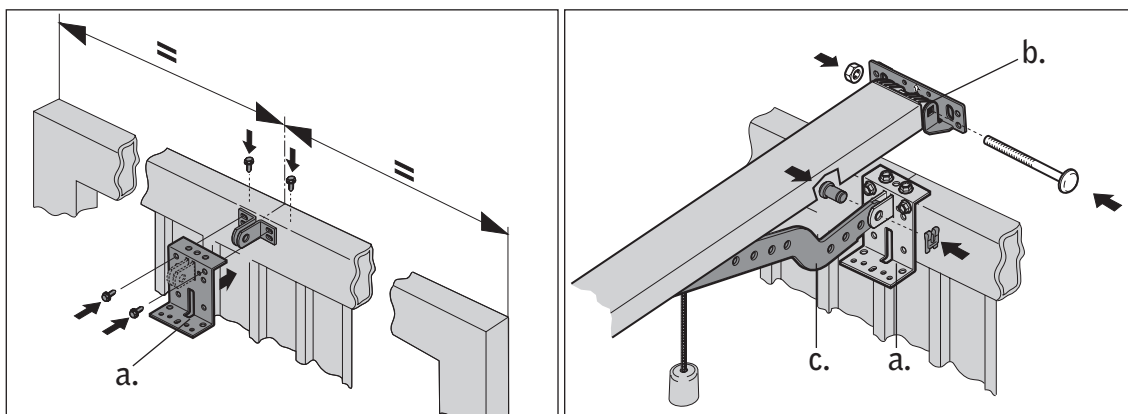

- Mettez l'entraînement dans une position horizontale à l'aide d'un support et fixez le côté moteur.

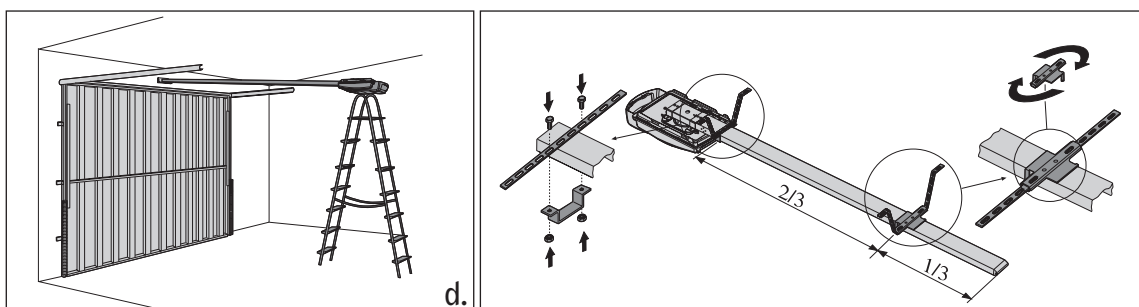

- Déverrouillez le chariot. Ouvrez ou fermez la porte lentement.
- Attachez le bras d'entraînement à la patte.

#### Attention!

Démontez tous les serrures et les verrouillages de la porte ou mettez-les hors d'usage.

**4B**

## Portes sectionnelles

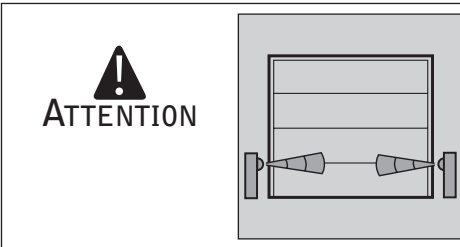
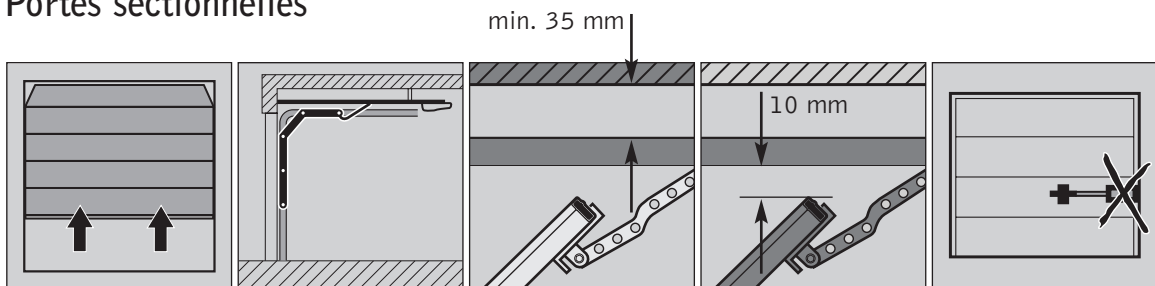

L'application d'une cellule photo-électrique est fortement conseillée.

- Réglez la console à l'hauteur exacte et fixez-la au milieu du panneau supérieure de la porte.

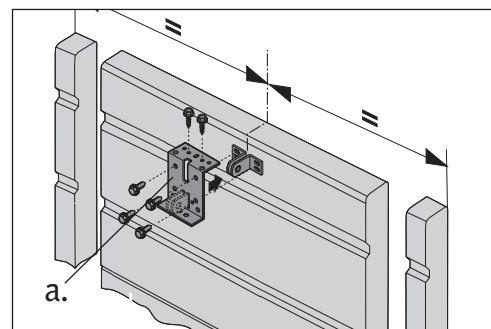

- Montez la patte (a) au milieu de la porte. Fixez l'étrier (b) du rail au-dessus de la porte, sur le dormant ou sur la poutre, de telle façon qu'il y ait un minimum 10 mm de jeu entre la partie la plus haute de la porte et le rail.

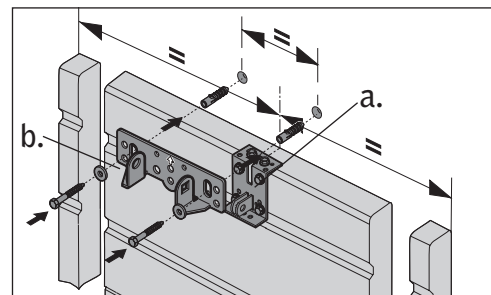

- Mettez l'entraînement dans une position horizontale à l'aide d'un support et fixez le côté moteur.

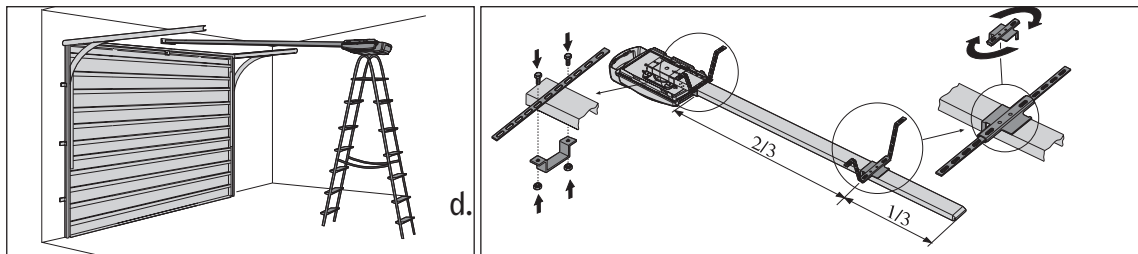

- Déverrouillez le chariot. Ouvrez ou fermez la porte lentement.
- Fixez la tige (c) en deux pièces à l'étrier (a).

**Attention! Démontez tous les serrures et les verrouillages de la porte ou mettez-les hors d'usage.**

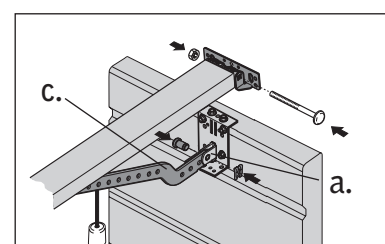

## 4C Porte non débordante

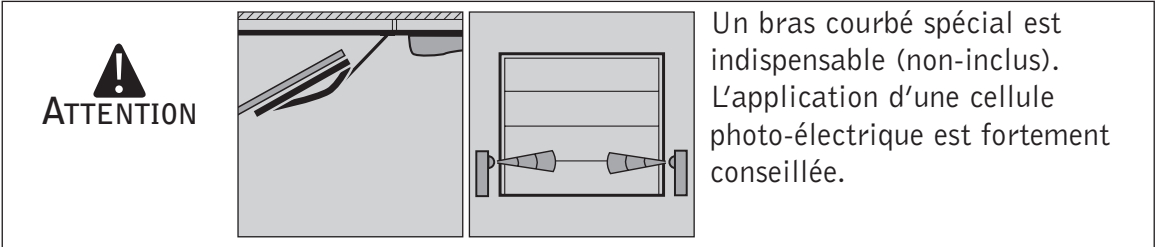
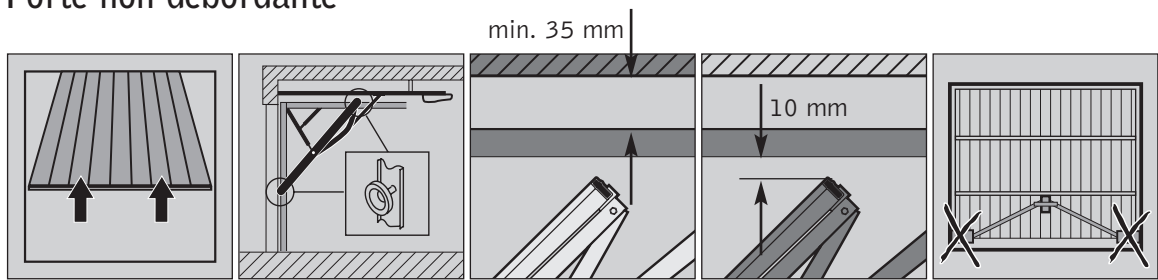

- Montez la patte (a) au milieu de la porte. Fixez l'étrier (b) du rail au-dessus de la porte, sur le dormant ou sur la poutre, de telle façon qu'il y a minimum 10 mm de jeu entre la partie la plus haute de la porte et le rail.

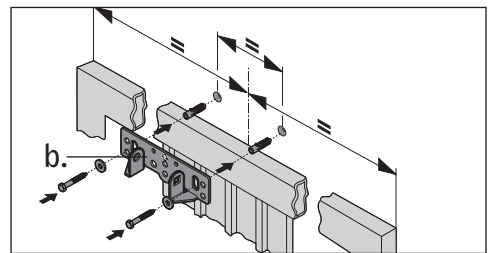

- Fixez le bras courbé selon les instructions du fournisseur du bras.
- Mettez l'entraînement dans une position horizontale à l'aide d'un support et fixez le côté moteur.

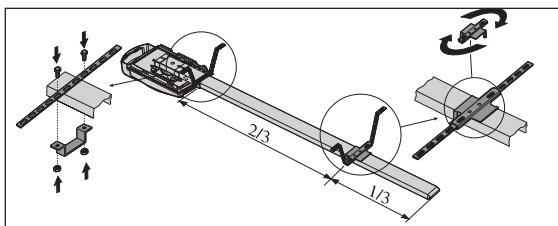
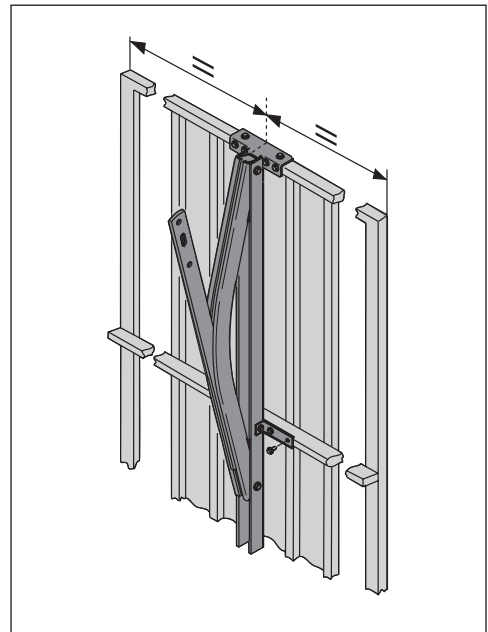
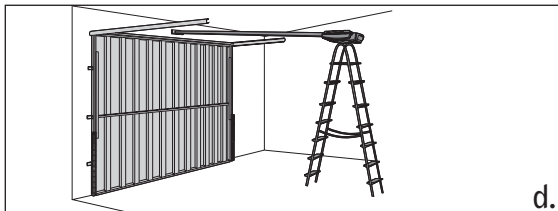

- Déverrouillez le chariot. Ouvrez ou fermez la porte lentement.
- Ouvrez la porte entièrement et connectez le bras d'entraînement avec le bras courbé. Fermez la porte manuellement et vérifiez si la distance entre le chariot et la porte est de min. 165 mm.

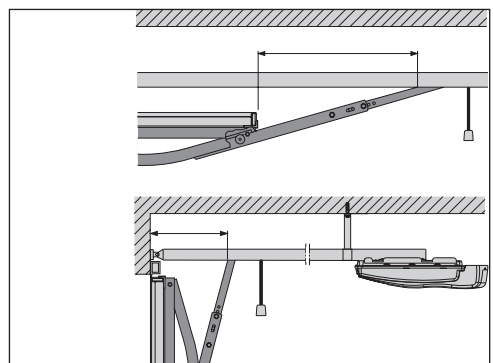

## 4D Portes non débordantes (guidées par rail vertical)

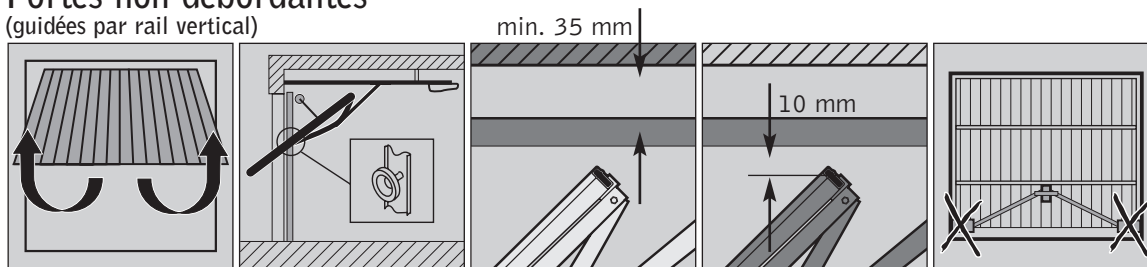

**ATTENTION**

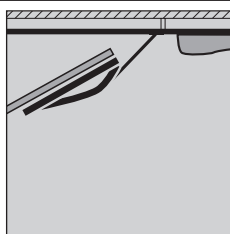

Un bras courbé (voir dessin) est indispensable (non inclus).

- Montez la patte (a) au milieu de la porte. Fixez l'étrier (b) du rail au-dessus de la porte, sur le dormant ou sur la poutre, de telle façon qu'il y a minimum 10 mm de jeu entre la partie la plus haute de la porte et le rail.

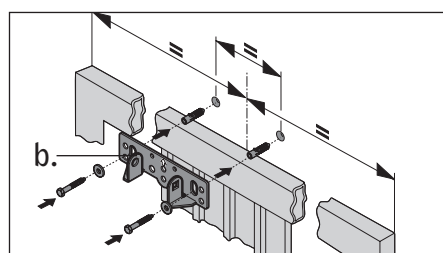

- Fixez le bras courbé selon les instructions du fournisseur du bras.
- Mettez l'entraînement dans une position horizontale à l'aide d'un support et fixez le côté moteur.

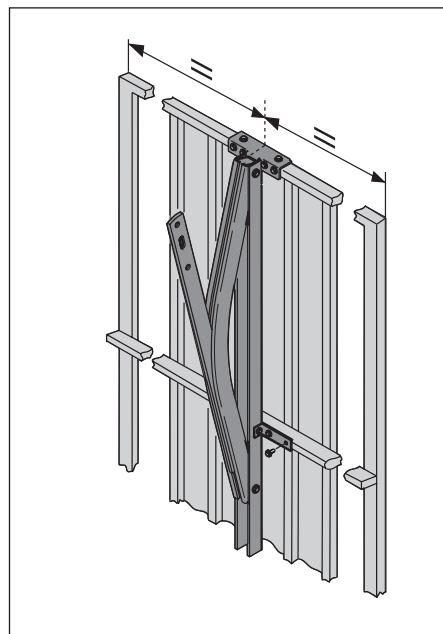
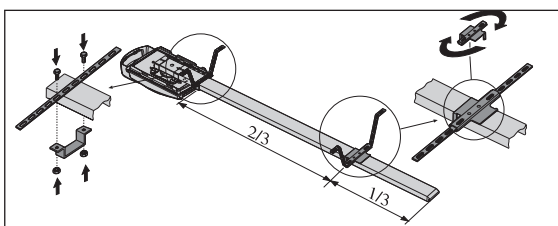
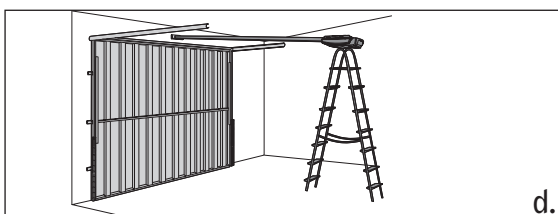

- Déverrouillez le chariot. Ouvrez ou fermez la porte lentement.
- Ouvrez la porte entièrement et connectez le bras d'entraînement avec le bras courbé. Fermez la porte manuellement et vérifiez si la distance entre le chariot et la porte est de min. 165 mm.

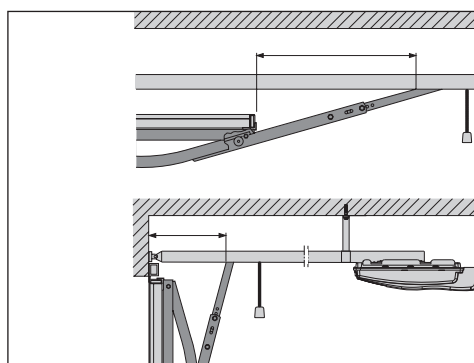











CONTACTEZ VOTRE FOURNISSEUR POUR TOUT AUTRE TYPE DE PORTE!

- 5 Vérifiez si l'entraînement et le rail sont bien montés et si tous les vis sont bien serrés. **⚠ Attention:** avant de programmer l'entraînement vous devez verrouiller le chariot et fixer le bras d'entraînement à la porte.
- 6 Posez la lampe.  
Type E14, max. 40 Watt (non inclus).



## INDICATIONS PANNEAU DE COMMANDE

Votre entraînement est équipé d'un panneau de commande simple avec 8 LEDs et 3 boutons de programmation.

### LED's

-  1 cellule photo-électrique externe
-  2 porte ouverte
-  3 fermeture automatique
-  4 porte fermée
-  5 éclairage 230V
-  6 dérèglement
-  7 impulsion (clignote lentement lorsque 'verrouillage de vacance')
-  8 en fonctionnement, alimentation secteur (230V)

### Boutons de programmation

-  Bouton de programmation pour "diminuer" et bouton test fermeture
-  Bouton de programmation pour "augmenter" et bouton test ouverture
-  Bouton de programmation

### EXPLICATION

|                         |      |   |
|-------------------------|------|---|
| LED éteint              | p.e. |  |
| LED allumé              | p.e. |  |
| LED clignote            | p.e. |  |
| LED clignote rapidement | p.e. |  |

Programmation standard: p.e.





Bouton appuyé  ou  ou 



Eclairage de l'entraînement allumé:  éteint: 

Eclairage externe allumé:  éteint: 

Une fois que l'entraînement est sous tension, il subit automatiquement un auto-test; les 8 LEDs et la lampe sont allumés pendant environ 2 secondes. L'entraînement est en fonctionnement dès que la lampe est éteinte et que le LED  est allumé.

### COMMENT PROGRAMMER ET ADAPTER LES REGLAGES:

Toutes les données et les adaptations sont programmées à l'aide des 3 boutons de programmation. Appuyez sur le bouton  pendant ca. 2 sec afin de passer du mode de service vers le mode de programmation. Lâchez le bouton  quand tous les LEDs sont allumés et que le LED  clignote. Vous entrez maintenant dans le mode de programmation des fonctions de base.

Utilisez les boutons  et  pour des changements dans le menu de programmation le bouton  pour mémoriser un choix de menu / une programmation.







### APERÇU MENU:

- ① Programmation de la cellule photo-électrique
- ② Programmation du fin de course 'Ouverture'
- ③ Programmation du fin de course 'Fermeture'
- ④ Programmation de la limitation de force pendant 'Ouverture'
- ⑤ Programmation de la limitation de force pendant 'Fermeture'

### REGLAGE DE L'ENTRAÎNEMENT:





#### Menu ①

PROGRAMMATION DE LA CELLULE PHOTO-ÉLECTRIQUE \* 

1. Appuyez sur bouton  pendant ca. 2 sec (LED  clignote, les autres LEDs sont allumés).
  2. A. Appuyez sur bouton  si vous installez une cellule photo-électrique (LED  est allumé).  
B. Appuyez sur bouton  si vous n'installez pas de cellule photo-électrique (LED  clignote).
  3. Appuyez sur bouton  pour mémoriser la fonction cellule photo-électrique et pour passer automatiquement au menu de programmation ②.
- \*La cellule photo-électrique est un accessoire optionnel.





#### Menu ②

PROGRAMMATION DU FIN DE COURSE OUVERTURE 

1. LED  clignote et tous les LEDs sont allumés.
2. Appuyez sur le bouton  de sorte que la porte atteigne la position ouverte souhaitée. Utilisez les boutons  (OUVERTURE) et  (FERMETURE) pour faire le réglage précis.
3. Appuyez sur  pour programmer le fin de course OUVERTURE et pour passer automatiquement au menu de programmation ③.

#### Menu ③





PROGRAMMATION DU FIN DE COURSE FERMETURE 

































































1. LED  clignote et tous les LEDs sont allumés.
2. Appuyez sur le bouton  de sorte que la porte atteigne la position fermée souhaitée. Utilisez les boutons  (FERMETURE) et  (OUVERTURE) pour faire le réglage précis.
3. Appuyez sur  pour programmer le fin de course FERMETURE et pour passer automatiquement au menu de programmation ④.

## Menu 4

### PROGRAMMATION DE LA FORCE MAXIMALE POUR L'OUVERTURE ET

Bien que l'entraînement soit équipé d'un réglage de force auto-programmant, nous vous conseillons fortement de programmer la force maximale nécessaire pour l'ouverture. Lorsque la force programmée manuellement est dépassée, elle est prioritaire à la force apprise initialement.

1. LED  et LED  clignotent et les autres LEDs sont allumés.
2. Appuyez sur les boutons  et  pour régler la force. Chaque LED allumé représente 1/8 de la force, donc quand il y a 1 seul LED 1 (1/8) qui est allumé, la force est minimale, lorsque tous les LEDs (8/8) sont allumés, la force est maximale.

|   |   |   |   |   |   |   |   |
|---|---|---|---|---|---|---|---|
|  <br> <br> <br> <br>1/8 |  <br> <br> <br> <br>2/8 |  <br> <br> <br> <br>3/8 |  <br> <br> <br> <br>4/8 |  <br> <br> <br> <br>5/8 |  <br> <br> <br> <br>6/8 |  <br> <br> <br> <br>7/8 |  <br> <br> <br> <br>8/8 |
|---|---|---|---|---|---|---|---|





3. Appuyez sur P pour programmer la force maximale pour l'ouverture et pour passer automatiquement au menu 5.

































































**⚠ Attention:** réglez le dispositif 'détection obstacles' aussi sensible que possible (max. 150 N sur la partie inférieure de la porte).

## Menu 5







### PROGRAMMATION DE LA FORCE MAXIMALE POUR LA FERMETURE ET

Bien que l'entraînement soit équipé d'un réglage de force auto-programmant, nous vous conseillons fortement de programmer la force maximale pour la fermeture. Lorsque la force programmée manuellement est dépassée, elle est prioritaire à la force apprise initialement.

1. LED  et LED  clignotent et les autres LEDs sont allumés.
2. Appuyez sur les boutons  et  pour régler la force. Chaque LED allumé représente 1/8 de la force, donc quand il y a 1 seul LED 1 (1/8) qui est allumé, la force est minimale, lorsque tous les LEDs (8/8) sont allumés, la force est maximale.

|   |   |   |   |   |   |   |   |
|---|---|---|---|---|---|---|---|
|  <br> <br> <br> <br>1/8 |  <br> <br> <br> <br>2/8 |  <br> <br> <br> <br>3/8 |  <br> <br> <br> <br>4/8 |  <br> <br> <br> <br>5/8 |  <br> <br> <br> <br>6/8 |  <br> <br> <br> <br>7/8 |  <br> <br> <br> <br>8/8 |
|---|---|---|---|---|---|---|---|

### MEMORISER LES PROGRAMMATIONS:

Appuyez sur  pour mémoriser la limitation de force pendant la fermeture et pour terminer la programmation des fonctions de base. Tous les LEDs s'éteignent un par un. (d'abord LED , LED , ...). L'entraînement est maintenant en état de service (LED  et éventuellement LED  ou LED  sont allumés).

**⚠ Attention:** réglez le dispositif "détection obstacles" aussi sensible que possible (max. 150 N sur la partie inférieure de la porte).









**ATTENTION:** Testez la sensibilité chaque mois et modifiez, si nécessaire, les réglages.

### CONNEXION RECEPTEUR:

Connectez le récepteur externe et programmez l'émetteur selon les instructions spécifiques.

### CHANGER LA PROGRAMMATION:

Modifier la programmation d'un seul menu:

1. Appuyez ca. 2 sec sur  (LED  clignote, les autres sont allumés).
2. Appuyez plusieurs fois sur  jusqu'à ce que le menu désiré est affiché (p.e. LED  et LED  clignotent et tous les autres LEDs sont allumés). Les réglages de chaque menu que vous passez sont gardés!
3. Suivez les instructions individuelles du menu choisi.
4. Appuyez sur  pour programmer le menu choisi, appuyez plusieurs fois sur P pour retourner à l'état de service. (LED  et éventuellement LED  ou LED  sont allumés).

Attention! Si la commande se trouve dans le mode de programmation et que aucun des trois boutons de programmation n'est appuyés endéans les 30 sec, la programmation est interrompue (erreur 7).

# MAC RC "ROLLING CODE" ÉMETTEURS

## Système digitale de télécommandes avec "rolling code"

Le MAC RC est un système de télécommandes en 433 MHz. Pour garantir une sécurité optimale le signal émis est une combinaison d'un code fixe unique et d'un "rolling code" qui évolue sans cesse. Grâce à ce système on obtient plus de 100.000.000.000.000.000 codes différents incopiables. Le mode de programmation peut être activé soit directement dans le récepteur, soit au moyen de l'émetteur. Cette seconde possibilité permet de programmer de nouveaux émetteurs dans un système existant au moyen d'un émetteur, p.e. quand le récepteur est difficilement accessible. Le code de l'émetteur est programmé dans la mémoire Eeprom du récepteur, où les données sont maintenues, même lors d'une interruption de courant. La programmation à distance permet également d'effacer un émetteur programmé. Les émetteurs/récepteurs sont conformes aux directives CE et aux normes I-ETS. Ils sont approuvés par le BIPT.

### 1. Généralités

Les émetteurs MAC RC "Rolling Code" sont reconnaissables à leurs boutons-poussoirs bleus. Il existent en trois versions: MAC RC 1(1 canal), MAC RC 2 (2 canaux) en MAC RC 4 (4 canaux). Tous les émetteurs sont pourvus d'une fonction permettant une économie de batterie qui met l'émetteur hors service lorsque le bouton-poussoir est appuyé pendant plus de 30 sec.

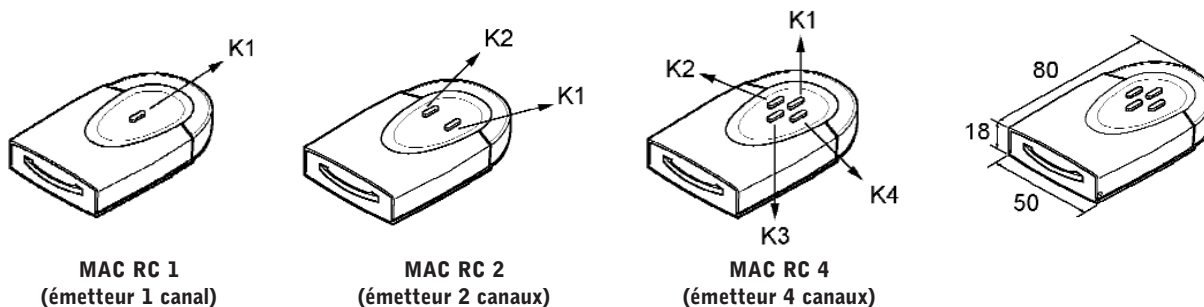

### 2. Programmation des émetteurs

Pour la programmation/suppression au moyen du bouton sur le récepteur nous vous renvoyons au manuel du récepteur.

#### 2.1. Ouvrir l'émetteur et Programmation du premier émetteur

Appuyez sur le bouton MEM. Appuyez sur le bouton bleu du canal désiré dès que l'émetteur émet un signal continu (endéans les 5 sec.). L'émetteur émet maintenant un signal interrompu. Le récepteur est programmé.

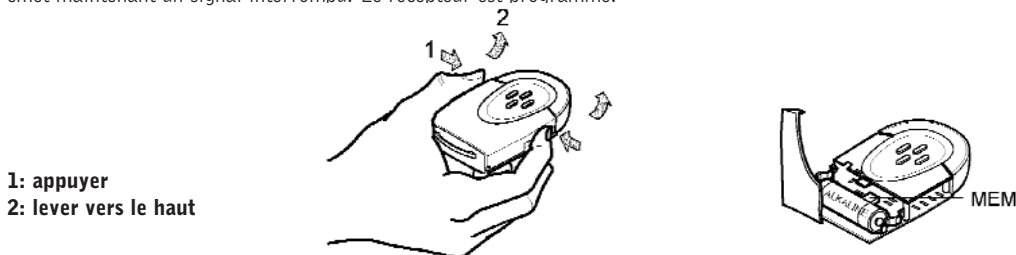

- 1: appuyer
- 2: lever vers le haut

#### ATTENTION!

La programmation du premier émetteur au moyen de l'émetteur est seulement possible quand la mémoire du récepteur est vide!

#### 2.2. Programmation d'un émetteur supplémentaire

Appuyez sur le bouton MEM de l'émetteur déjà programmé. Appuyez endéans les 5 secondes le bouton déjà programmé sur l'émetteur déjà programmé dès que le récepteur émet un signal continu. Le bip est interrompu brièvement. Ensuite vous appuyez endéans les 5 secondes sur le bouton-poussoir à programmer. Le récepteur émet un signal interrompu. Le bouton-poussoir supplémentaire de l'émetteur est programmé.

#### 2.3. Effacer un émetteur de la mémoire au moyen de l'émetteur

Appuyez endéans les 5 sec. trois fois sur le bouton MEM de l'émetteur déjà programmé. La première fois le récepteur émet un signal continu. La troisième fois le récepteur émet un signal interrompu. Appuyez maintenant sur le bouton du canal à effacer. Le récepteur arrête immédiatement l'émission du signal.

### 3. Données techniques

|                               | MAC RC 1                   | MAC RC 2                   | MAC RC 4                   |
|-------------------------------|----------------------------|----------------------------|----------------------------|
| Fréquence                     | 433,92 MHz                 | 433,92 MHz                 | 433,92 MHz                 |
| Alimentation                  | 12 V DC (batterie GP 23 A) | 12 V DC (batterie GP 23 A) | 12 V DC (batterie GP 23 A) |
| Puissance apparente irradiée  | -10+/-7 dBm (100-200mW)    | -10+/-7 dBm (100-200mW)    | -10+/-7 dBm (100-200mW)    |
| Consommation moyenne          | 28 mA                      | 28 mA                      | 28 mA                      |
| Nombre de canaux              | 1                          | 2                          | 4                          |
| Température de fonctionnement | -10 °C / +55°C             | -10 °C / +55°C             | -10 °C / +55°C             |
| Fonction économie de batterie | après 30 sec.              | après 30 sec.              | après 30 sec.              |

Les émetteurs/récepteurs sont conformes aux directives CE et aux normes I-ETS. Ils sont approuvés par le BIPT.

## 1. Généralités

Le MAC RX 35 est une platine réceptrice sur 433,92 MHz compatible avec les émetteurs MAC RC et MAC RD.  
Le récepteur RX 35 est incorporé dans le MAC TRONIC.

## 2. La programmation du récepteur

**POUR LA PROGRAMMATION ET LA SUPPRESSION AU MOYEN DE L'EMETTEUR NOUS VOUS RENVOYONS AU MANUEL DE L'EMETTEUR**

### 2.1. La connexion du récepteur

Le récepteur RX35 se trouve au-dessous du capot de la lampe du MAC TRONIC.

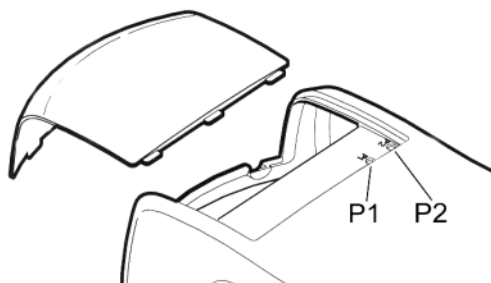

### 2.2. Réglage et programmation

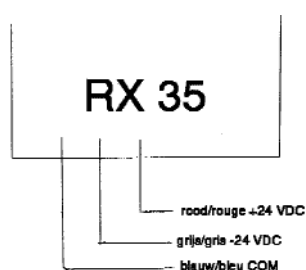
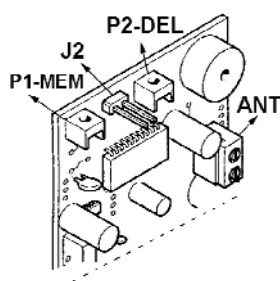

#### **P1-MEM = bouton de programmation**

- 1) Appuyez et maintenez appuyé P 1. Après 0,8 sec. le buzzer sonore émet un signal continu.
- 2) Emettez en même temps le canal à mémoriser. Le buzzer émet un signal intermittent. Répétez les actions 1) et 2) pour introduire un nouveau code.

#### **J 2 = pontage**

- Pôles pontés: pour fonctionnement avec les émetteurs MAC RD (boutons-poussoirs rouges).  
Pôles non pontés: pour le fonctionnement avec les émetteurs MAC RC (boutons-poussoirs bleus).

#### **P2-DEL = bouton de suppression. Effacer 1 code**

- 1) Appuyez et maintenez appuyé P2. Après 0,8 sec le buzzer émet un signal intermittent.
- 2) Emettez en même temps le code à effacer. Dès que le code est effacé, le buzzer émet un signal continu. Répétez les actions 1) et 2) pour effacer un autre code.

#### **Effacer tous les codes**

Appuyez et maintenez appuyé P2. Après 0,8 sec. le buzzer émet un signal interrompu. Lâchez maintenant P2 et appuyez-le à nouveau endéans les 0,5 sec. Maintenez-le pendant 10 sec. jusqu'à ce que le buzzer émet un signal continu. Lâchez maintenant P2.

#### **ANT = connexion pour l'antenne**

Un fil de cuivre isolé de 170mm est toujours fourni.

Lors de l'utilisation d'une antenne externe type MAC ANT GP 433 le manteau du coax RG 58 coax doit être branché au vis droit (masse). La longueur totale du coax ne peut pas dépasser les 10 mètres.

## 3. Données techniques

|   |                            |
|---|----------------------------|
| <b>Fréquence</b>                                      | <b>RX 35</b><br>433,92 MHz |
| <b>Mémoire</b>  | MEM 85 soudé               |
| <b>Alimentation</b>                                   | 8-12 V DC                  |
| <b>Puissance absorbée max. lors de repos</b>          | 14mA                       |
| <b>Puissance absorbée max. lors de fonctionnement</b> | 14mA                       |
| <b>Charge max. du relais</b>                          | collecteur ouvert 30mA     |
| <b>Température de fonctionnement</b>                  | -10°C / +55°C              |
| <b>Impédance antenne</b>                              | 50 W                       |

## BRANCHEMENTS EXTERNES

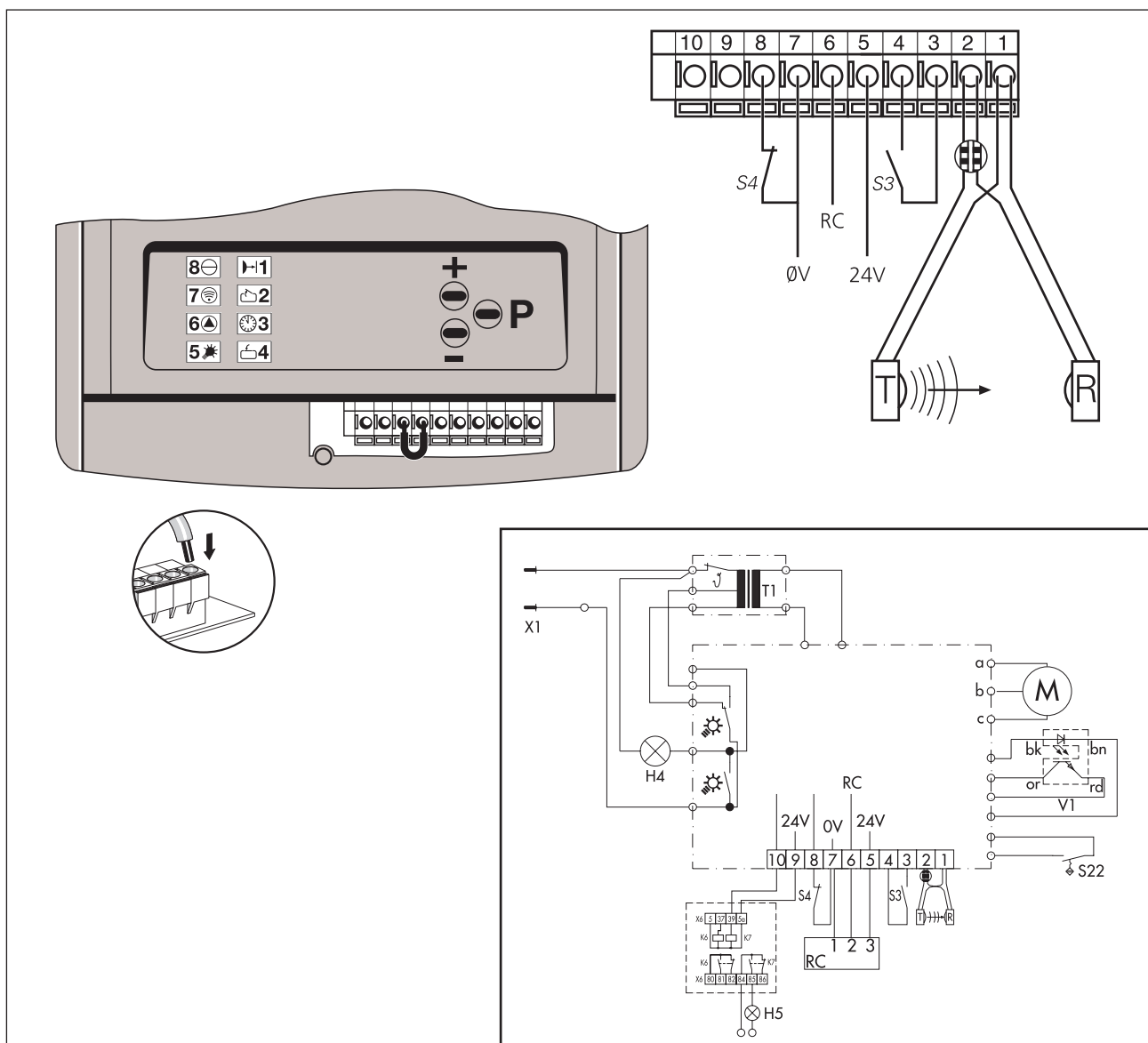

|     |   |
|-----|---|
| M   | moteur  |
| T1  | transformateur  |
| V1  | senseur compte-tours                                      |
| S22 | interrupteur de point de référence                        |
| T   | cellule photo-électrique émetteur                         |
| R   | cellule photo-électrique récepteur                        |
| S3  | bouton-poussoir IMPULSION<br>(contact normalement ouvert) |
| S4  | bouton-poussoir<br>(contact normalement fermé)            |
| X1  | fiche 1~N 220-240V 50 Hz                                  |
| H4  | lampe d'éclairage   |
| H5  | lampe de signalisation                                    |
| RC  | contact relais  |
| 0V  | terre   |
| 24V | 24 V cc, 50Ma max.  |

|    |            |
|----|------------|
| bk | noir       |
| bn | brun       |
| or | orange     |
| rd | rouge      |
| a  | brun       |
| b  | vert/jaune |
| c  | vert       |

Il est possible de connecter soit un bouton-poussoir ou une console murale à 3 fonctions (impulsion, éclairage allumé/éteinte et verrouillage de vacances). Si le LED 8 est allumé et que le LED 7 clignote, le verrouillage de vacances est activé.

Désactivez le 'Deverrouillage de vacances' au moyen la console murale ou par appuyez le bouton **EP** brièvement.

## QUE FAIRE EN CAS DE DEREGLEMENTS

| Indication de dérèglement  | Cause   | Solution   |
|--|---|--|
| LED 8 éteint   | Pas d'alimentation.   | Vérifiez l'alimentation.<br>Vérifiez la prise de courant.  |
|  | La protection thermique du transfo est déclenché                                      | Laissez refroidir le transfo.  |
|  | Platine de commande défectueuse.  | Coupez l'alimentation. Dévisser la platine de commande et faites vérifier.   |
| LED 6 clignote.<br>Erreur 10   | Système 'Détection obstacles' trop sensible.<br>La porte fonctionne mal ou se bloque. | Réglez de nouveau le système 'Détection obstacles' (Menu 4, Menu 5). Faites le nécessaire pour que le mouvement de la porte soit souple. |
| LED 6 clignote.<br>Erreur 6 ou 15.   | Cellule photo-électrique défectueuse ou rayon interrompu.                             | Faites contrôler la cellule photo-électrique ou enlevez l'obstruction.   |
| La porte s'ouvre, mais ne se ferme pas.<br>Erreur 15.  | Cellule photo-électrique Menu 1 est programmée, mais pas raccordée.                   | Adaptez la programmation de la cellule photo-électrique ou raccordez la cellule.   |
| Pas de réaction après impulsion.<br>LED 7 est allumé   | Court-circuit aux bornes de connexion du contact d'impulsion.                         | Déconnectez tous les conducteurs des bornes d'impulsion, reconnectez-les ensuite un par un et vérifiez le fonctionnement correcte.       |
| Pas de réaction après impulsion.<br>Erreur 36.   | Pontage S4 (normalement fermé) enlevé, sans que le bouton STOP a été branché.         | Branchez le bouton STOP.   |
| Pas de fonctionnement avec l'émetteur, fonctionne seulement avec la console murale.<br>Led 8 est allumé, Led 7 clignote. | L'entraînement est en position 'Déverrouillage de vacances'.                          | Désactivez le 'Deverrouillage de vacances' au moyen de la console murale ou par appuyez le bouton EP brièvement.                         |
| LED 6 clignote.<br>Erreur 9.   | Senseur compte-tours défectueux.  | Faites vérifier l'entraînement.  |
|  | La porte fonctionne mal.  | Faites contrôler la porte.   |

LA DIAGNOSE EST VISUALISÉE QUAND LE BOUTON EP EST APPUYÉE BRIÈVEMENT.

LED clignote irrégulièrement

6

7

8

8 + 11

8 + 2

8 + 3

8 + 7

8 + 7 + 11

8 + 7 + 6 + 5 + 2

8 + 7 + 6 + 5 + 11

8 + 7 + 6 + 5 + 4 + 3 + 2 + 11

Erreur no.

6

7

8

9

10

11

15

16

28

27

36

Dérèglement

Circuit cellule photo-électrique interrompu.

Programmation interrompue.

Point de référence défectueux.

Senseur compte-tours défectueux.  
Système détection obstacles activé.

Limitation de force.

Limitation du temps de marche.

Test cellule photo-électrique négatif.

Test limitation de force.

Limitation de force auto-programmante

'plus-value' sensibilité limitation de force

Rupture du circuit de veille.

## PROGRAMMATION DE LA PLATINE DE COMMANDE - REGLAGE AVANCEES

Avertissement -

La programmation des réglages avancées ne peut être faite que par un spécialiste.

### POSSIBILITES AVANCEES DE PROGRAMMATION ET D'EXTENSION:

- Fermeture automatique (Niveau 3).
- Adaptation réglages automatiques de la force et de l'éclairage (Niveau 4).
- Eclairage / lampes de signalisation (Niveau 5).

## PROGRAMMATION DE LA PLATINE DE COMMANDE - FERMETURE AUTOMATIQUE (NIVEAU 3)

Avertissement - Lors de l'activation de la fonction 'fermeture automatique' une cellule photo-électrique doit être branchée selon le menu ❶ dans les fonctions de base.

### APERÇU MENU (N3):









- ❶ Temporisation durée 'porte ouverte' (fermeture automatique).
- ❷ Programmation temps de présignalisation avant fermeture.
- ❸ Programmation temps de présignalisation avant ouverture.  
(à utiliser avec une lampe de signalisation)
- ❹ Refermeture prématurée après passage devant la cellule photo-électrique.
- ❺ Reset des menus du niveau 3

































### PROGRAMMATION FERMETURE AUTOMATIQUE:

Menu ❶ (N3)

#### TEMPORISATION DURÉE 'PORTE OUVERTE' (FERMETURE AUTOMATIQUE)

La commande est en état de fonctionnement.

1. Appuyez les boutons de programmation ,  et  simultanément pendant ca. 10 sec. jusqu'à ce que le LED  clignote et que tous les autres sont allumés.
2. Lâchez  (LED  clignote).
3. Utilisez les boutons  et  pour programmer la durée 'porte ouverte'  
durée minimale: 5 secondes  
durée maximale: 255 secondes

|   |   |   |   |   |   |   |   |   |   |   |   |   |   |   |   |
|---|---|---|---|---|---|---|---|---|---|---|---|---|---|---|---|
|   |   |   |   |   |   |   |   |   |   |   |   |   |   |   |   |
| Minuteur<br>désactivé   | 5   | 10  | 15  | 20  | 25  | 30  | 35  | 40  | 50  | 80  | 100   | 120   | 150   | 180   | 255   |
|   | secondes  | secondes  | secondes  | secondes  | secondes  | secondes  | secondes  | secondes  | secondes  | secondes  | secondes  | secondes  | secondes  | secondes  | secondes  |



4. Appuyez sur  pour mémoriser la durée 'porte ouverte' et passer automatiquement au menu ❷.



















































































## Menu ② (N3)

### PROGRAMMATION TEMPS DE PRÉSIGNALISATION AVANT FERMETURE

Une fois que la durée 'porte ouverte' est programmée le LED  clignote.

1. Contrôlez si le LED  clignote et si tous les autres LEDs sont allumés.
2. Utilisez les boutons  et  pour programmer le temps de présignalisation.



Durée minimale: 2 secondes  
Durée maximale: 70 secondes

|   |   |   |   |   |   |  |   |   |   |   |   |   |   |   |   |  |   |   |   |
|---|---|---|---|---|---|--|---|---|---|---|---|---|---|---|---|--|---|---|---|
|     |     |     |     |     |     |     |     |     |     |     |     |     |     |     |     |     |     |     |     |
| Minuteur désactivé  | 2 secondes  | 5 secondes  | 10 secondes   | 15 secondes   | 20 secondes   | 25 secondes  | 30 secondes   | 35 secondes   | 40 secondes   | 45 secondes   | 50 secondes   | 55 secondes   | 60 secondes   | 65 secondes   | 70 secondes   |  |   |   |   |

































3. Appuyez sur  pour mémoriser le temps de présignalisation et pour passer au menu .

## Menu ③ (N3)

### PROGRAMMATION TEMPS DE PRÉSIGNALISATION AVANT DÉMARRAGE (TEMPS AVANT QUE LA PORTE S'OUVRE)

1. Contrôlez si le LED  clignote et si les autres sont allumés.
2. Utilisez les boutons  et  pour programmer le temps de présignalisation avant le démarrage.





Durée minimale: 0 secondes  
Durée maximale: 7 secondes

|   |   |   |   |   |  |   |   |
|---|---|---|---|---|--|---|---|
|     |     |     |     |     |     |     |     |
| 0 secondes  | 1 secondes  | 2 secondes  | 3 secondes  | 4 secondes  | 5 secondes   | 6 secondes  | 7 secondes  |

3. Appuyez sur  mémoriser la programmation et pour passer au menu .

## Menu ④ (N3)

### REFERMETURE PRÉMATURÉE APRÈS PASSAGE DEVANT LA CELLULE PHOTO-ÉLECTRIQUE

1. Contrôlez si le LED  clignote et si les autres sont allumés.
2. Utilisez les boutons  et  pour choisir le réglage désiré:
  - A. LED  clignote: La porte se ferme après l'expiration du temps programmé
  - B. LED  est allumé: La porte se ferme après passage devant la cellule photo-électrique

|   |   |
|---|---|
|     |     |
| La porte se ferme après l'expiration du temps programmé   | La porte se ferme après passage devant la cellule photo-électrique  |

3. Appuyez sur  pour valider votre choix et pour terminer le niveau 3 de programmation avancée "Fermeture automatique".

Les LEDs s'éteignent un par un, à commencer par le LED . L'entraînement est maintenant en état de fonctionnement; le LED  et éventuellement le LED  (porte entièrement ouverte) ou le LED  (porte entièrement fermée) sont allumés.

## Menu 5 (N3)

### RESET DES MENUS NIVEAU 3

Appuyez les boutons de programmation et simultanément pendant au moins 20 secondes. Reset sera complet quand les LED's s'éteignent un par un à commencer par le LED à finir avec le LED .

L'entraînement et maintenant en état de fonctionnement. Le LED et éventuellement le LED (porte entièrement ouverte) ou le LED (porte entièrement fermée) sont allumés.

## PROGRAMMATION REGLAGES AUTOMATIQUES DE LA FORCE ET DE L'ECLAIRAGE (N4)

Avertissement - La programmation des réglages avancés ne peut être faite que par un spécialiste.

### APERÇU MENU (N4):

- 1 Programmation durée de l'éclairage
- 2 Programmation plus-value de la force auto-programmée
- 3 Programmation plus-value force auto-programmée pendant vitesse réduite.

### L'ADAPTATION DES RÉGLAGES AUTOMATIQUES DE LA FORCE ET DE L'ÉCLAIRAGE:

1. En état de fonctionnement, appuyez les boutons , et simultanément pendant ca. 10 sec. jusqu'à ce que le LED clignote et que les autres LEDs sont allumés.
2. Maintenez le bouton appuyé et sélectionnez le Niveau 4 à l'aide des boutons ou (LED clignote rapidement).
3. Lâchez .

## Menu 1 (N4)

### PROGRAMMATION DURÉE DE L'ÉCLAIRAGE (💡)

1. LED clignote et les autres LEDs sont allumés.
2. Utilisez les boutons et pour programmer la durée de l'éclairage.  
Durée minimale: 90 secondes  
Durée maximale: 240 secondes

|          |          |          |          |          |          |          |          |          |          |          |          |          |          |          |          |
|----------|----------|----------|----------|----------|----------|----------|----------|----------|----------|----------|----------|----------|----------|----------|----------|
|          |          |          |          |          |          |          |          |          |          |          |          |          |          |          |          |
|          |          |          |          |          |          |          |          |          |          |          |          |          |          |          |          |
|          |          |          |          |          |          |          |          |          |          |          |          |          |          |          |          |
|          |          |          |          |          |          |          |          |          |          |          |          |          |          |          |          |
| 90       | 95       | 100      | 110      | 120      | 130      | 140      | 150      | 160      | 170      | 180      | 190      | 200      | 210      | 220      | 240      |
| secondes | secondes | secondes | secondes | secondes | secondes | secondes | secondes | secondes | secondes | secondes | secondes | secondes | secondes | secondes | secondes |

3. Appuyez sur pour mémoriser la programmation et pour passer automatiquement au menu .

## Menu 2 (N4)

### PROGRAMMATION PLUS-VALUE DE LA FORCE AUTO-PROGRAMMÉE

1. LED clignote et les autres LEDs sont allumés.
2. Utilisez les boutons et pour augmenter ou diminuer la 'plus-value' par étapes de 1/15.  
plus-value minimale: 1/15  
plus-value maximale: 15/15

|           |      |      |      |      |      |      |      |      |      |       |       |       |       |       |       |
|-----------|------|------|------|------|------|------|------|------|------|-------|-------|-------|-------|-------|-------|
|           |      |      |      |      |      |      |      |      |      |       |       |       |       |       |       |
|           |      |      |      |      |      |      |      |      |      |       |       |       |       |       |       |
|           |      |      |      |      |      |      |      |      |      |       |       |       |       |       |       |
|           |      |      |      |      |      |      |      |      |      |       |       |       |       |       |       |
| désactivé | 1/15 | 2/15 | 3/15 | 4/15 | 5/15 | 6/15 | 7/15 | 8/15 | 9/15 | 10/15 | 11/15 | 12/15 | 13/15 | 14/15 | 15/15 |

3. Appuyez sur pour mémoriser la programmation et passer automatiquement au menu .

### Menu 3 (N4)

#### PROGRAMMATION PLUS-VALUE DE LA FORCE AUTO-PROGRAMMÉE PENDANT VITESSE RÉDUITE

1. LED clignote et les autres LEDs sont allumés.
2. Utilisez les boutons et pour augmenter ou diminuer la 'plus-value' de la force auto-programmée en vitesse réduite' par étapes de 1/15.  
plus-value minimale: 1/15  
plus-value maximale: 15/15

|           |      |      |      |      |      |      |      |      |      |       |       |       |       |       |       |
|-----------|------|------|------|------|------|------|------|------|------|-------|-------|-------|-------|-------|-------|
|           |      |      |      |      |      |      |      |      |      |       |       |       |       |       |       |
|           |      |      |      |      |      |      |      |      |      |       |       |       |       |       |       |
|           |      |      |      |      |      |      |      |      |      |       |       |       |       |       |       |
|           |      |      |      |      |      |      |      |      |      |       |       |       |       |       |       |
| désactivé | 1/15 | 2/15 | 3/15 | 4/15 | 5/15 | 6/15 | 7/15 | 8/15 | 9/15 | 10/15 | 11/15 | 12/15 | 13/15 | 14/15 | 15/15 |

3. Appuyez sur pour mémoriser la programmation et pour terminer le niveau 4 de programmation avancée "Réglages automatiques de la force et de l'éclairage".

Les LEDs s'éteignent un par un, à commencer par le LED . L'entraînement est maintenant en état de fonctionnement; le LED et éventuellement le LED (porte entièrement ouverte) ou le LED (porte entièrement fermée) sont allumés.

## PROGRAMMATION DE L'ÉCLAIRAGE / LAMPES DE SIGNALISATION (NIVEAU 5)

Avertissement - La programmation des réglages avancés ne peut être faite que par un spécialiste.

### APERÇU MENU (N5):

- 1 Programmation de la limitation du temps de marche
- 2 Programmation des lampes externes de signalisation
- 3 Programmation de l'éclairage de l'entraînement
- 4 Programmation du relais lumière externe - kit (box)

### L'ADAPTATION DE L'ÉCLAIRAGE ET/OU LAMPES DE SIGNALISATION:

1. Appuyez simultanément sur les boutons , et pendant ca. 10 sec. jusqu'à ce que le LED clignote et que les autres LEDs sont allumés.
2. Appuyez sur et sélectionnez le niveau 5 à l'aide des boutons et .
3. Lâchez .

### Menu 1 (N5)

#### PROGRAMMATION DE LA LIMITATION DU TEMPS DE MARCHÉ





1. LED clignote et les autres LEDs sont allumés.
2. Utilisez les boutons et pour programmer la durée de l'éclairage.  
Durée minimale: 30 secondes  
Durée maximale: 240 secondes

|             |             |             |             |             |             |              |              |              |              |              |              |              |              |              |              |
|-------------|-------------|-------------|-------------|-------------|-------------|--------------|--------------|--------------|--------------|--------------|--------------|--------------|--------------|--------------|--------------|
|             |             |             |             |             |             |              |              |              |              |              |              |              |              |              |              |
|             |             |             |             |             |             |              |              |              |              |              |              |              |              |              |              |
|             |             |             |             |             |             |              |              |              |              |              |              |              |              |              |              |
|             |             |             |             |             |             |              |              |              |              |              |              |              |              |              |              |
| 30 secondes | 40 secondes | 50 secondes | 55 secondes | 65 secondes | 80 secondes | 100 secondes | 120 secondes | 140 secondes | 160 secondes | 180 secondes | 190 secondes | 200 secondes | 210 secondes | 220 secondes | 240 secondes |

3. Appuyez sur pour mémoriser la programmation et passer automatiquement au menu .

## Menu ② (N5)

### PROGRAMMATION DES LAMPES EXTERNES DE SIGNALISATION (☀/☾)





1. LED  clignote et les autres LEDs sont allumés.
2. Utilisez les boutons  et  pour programmer l'éclairage.  
LED  clignote: les lampes externes sont allumées (alimentation continue)  
LED  est allumé: les lampes externes clignotent (alimentation interrompue)









|   |  |
|---|--|
| <br><br><br><br>les lampes externes sont allumées | <br><br><br><br>les lampes externes clignotent |
|---|--|

3. Appuyez sur  pour mémoriser la programmation et passer automatiquement au menu ③.

## Menu ③ (N5)

### PROGRAMMATION DE L'ÉCLAIRAGE DE L'ENTRAÎNEMENT (💡/💡)





1. LED  clignote et les autres LEDs sont allumés.
2. Utilisez les boutons  et  pour programmer l'éclairage.  
LED  clignote: la lampe est allumée pendant la durée programmée de l'éclairage  
LED  est allumé: la lampe clignote pendant le temps de présignalisation









|  |   |
|--|---|
| <br><br><br><br>la lampe est allumée pendant la durée programmée de l'éclairage | <br><br><br><br>la lampe clignote pendant le temps de présignalisation |
|--|---|

3. Appuyez sur  pour mémoriser la programmation et passer automatiquement au menu ④.





## Menu ④ (N5)

### PROGRAMMATION DU RELAIS LUMIÈRE EXTERNE (KIT BOX)

1. LED  clignote et les autres LEDs sont allumés.
2. Utilisez les boutons  et  pour programmer l'éclairage externe.  
LED  clignote: la lampe externe est allumée pendant la durée programmée de l'éclairage  
LED  est allumé: relais lumière externe se ferme durant 30 secondes pour transmission d'alarme sur tentative d'effraction

|   |  |
|---|--|
| <br><br><br><br>la lampe externe est allumée pendant la durée programmée de l'éclairage | <br><br><br><br>relais lumière externe se ferme durant 30 secondes pour transmission d'alarme sur tentative d'effraction |
|---|--|

3. Appuyez sur  pour mémoriser la programmation et pour terminer le niveau 5 de programmation avancée "Programmation de l'éclairage / lampes de signalisation".

Les LEDs s'éteignent un par un, à commencer par le LED . L'entraînement est maintenant en état de fonctionnement; le LED  et éventuellement le LED  (porte entièrement ouverte) ou le LED  (porte entièrement fermée) sont allumés.

## DONNÉES TECHNIQUES:

### MAC Tronic 100

Opérateur pour porte de garage

#### Connexion

230 V

250 W (lors de fonctionnement avec éclairage)

3,9 W (lors de repos sans éclairage)

#### Vitesse de mouvement:

0,14 m/sec. avec softstart et softstop

#### Force de traction et de poussée:

1000 N

#### Limitation du temps de marche:

88 sec. (réglable)

#### Eclairage:

1 x 40W (type E14), réglable entre 90 - 240 sec.

#### Tension du circuit de commande:

Basse tension inférieure à 24 V cc

#### Refermeture automatique:

Pour la fermeture automatique de la porte des cellules photo-électriques optionnelles sont indispensables. Présignalisation avant fermeture programmable de 2 à 70 sec. Temps d'ouverture programmable de 5 à 255 sec. Un relais lumière externe est disponible en option pour le raccordement des lampes de signalisation.

#### Dispositif de sécurité:

Limitation de force électronique par microprocesseur et senseur de courant.

#### Dispositif de blocage:

Par microprocesseur et senseur compte-tours.

#### Dispositif de sécurité contre ouverture forcée:

Sécurité électronique anti-ouverture en position fermée, la porte se referme automatiquement après détection d'un mouvement indésirable de ca. 1 cm. direction ouverture.

#### Degré de protection:

Uniquement approprié pour installation à des endroits non-humides.

**⚠ Attention:** Tenez compte des consignes de sécurité locales!

Pour éviter des phénomènes d'induction, il est impératif de séparer dans des gaines différentes les câbles de basse tension (bouton-poussoir, cellule photo-électrique,...) et ceux de l'alimentation.

**⚠ Attention:** Ne donnez une commande d'ouverture ou de fermeture que lorsque la porte est à portée de vue et que vous êtes sûrs qu'il n'y pas de personnes ou d'objets dans le champ de mouvement de la porte.

### Entretien

Cet opérateur ne nécessite pas d'entretien particulier. Toutefois il est conseillé de faire contrôler régulièrement les pièces mobiles de la porte et de l'entraînement est de vérifier régulièrement à la main si la porte fonctionne bien et si elle est bien équilibrée.

## Manufacturers Declaration

We hereby declare that the product referred to below, with reference to its design, construction and to the version as marketed by us, conforms to the relevant safety and health requirements contained in the European Council Directives pertaining to electromagnetic compatibility, machines and low voltage.

This declaration becomes null and void in the event of modification or changes to the product not expressly agreed with us.

### MAC Tronic 100

Relevant European Council Directives pertaining to electromagnetic compatibility (89/336/EEC, 93/68/EEC and 93/44/EEC), machines (89/392/EEC, 91/368/EEC, 93/68/EEC and 93/44/EEC) and low voltage (73/23/EEC, 93/68/EEC and 93/44/EEC).

To agreed standards: EN55014  
EN60555-2  
EN60555-3  
EN40082-1  
EN60335-1

To National standard and technical specification:  
ETS300220

July 1, 1998 A.M.Q. Enneking

Date / Signature

E-King bv  
P.O. Box 75089  
1070 AB Amsterdam

Technical alterations reserved.

Copyright  
E-King b.v.

**Vanhalme Nv/Sa**  
Industriepark „Waggelwater“  
Lieven Bauwensstraat 13  
8200 Brugge  
Telefoon: 050 - 32 02 02  
Telefax: 050 - 32 02 42

# SCHEMA DE PROGRAMMATION MAC TRONIC 100

## Fonctionnement normal

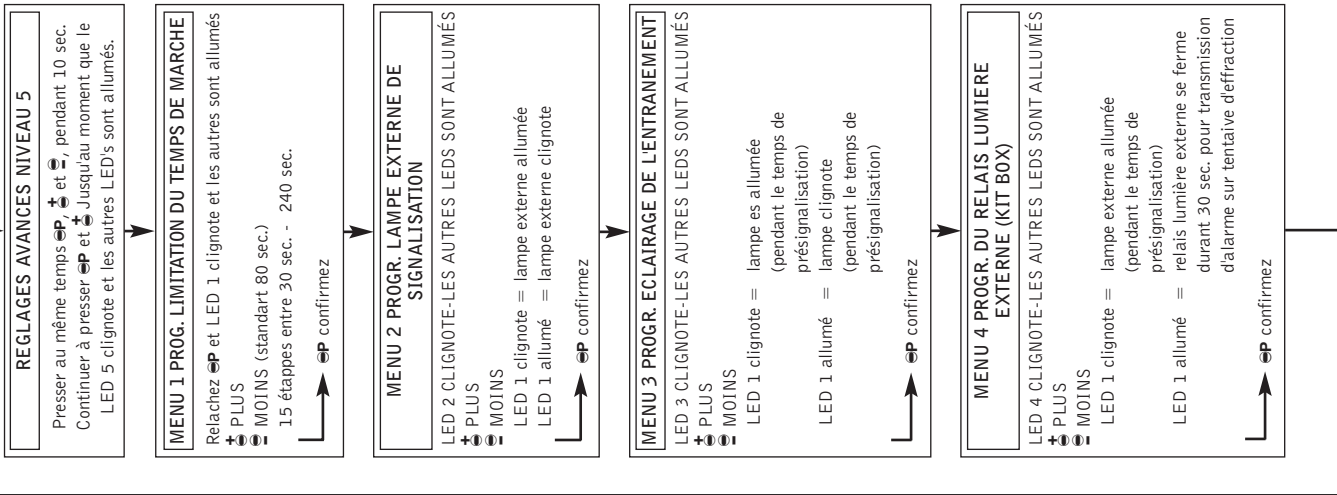
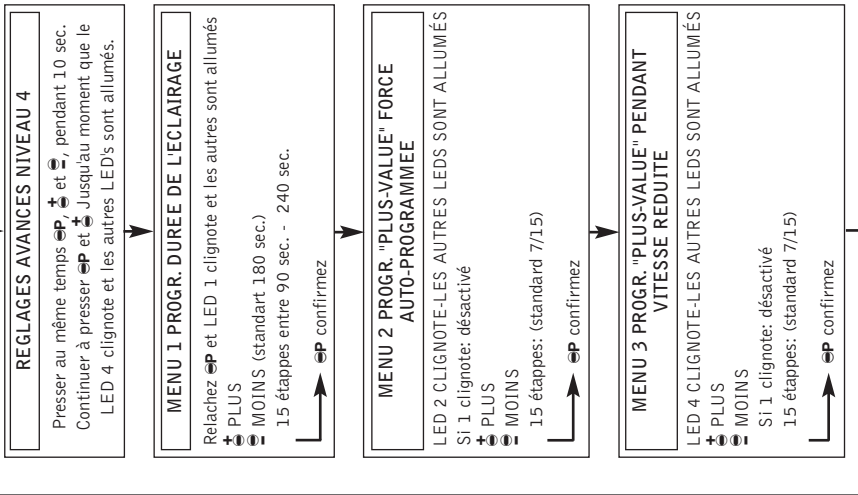
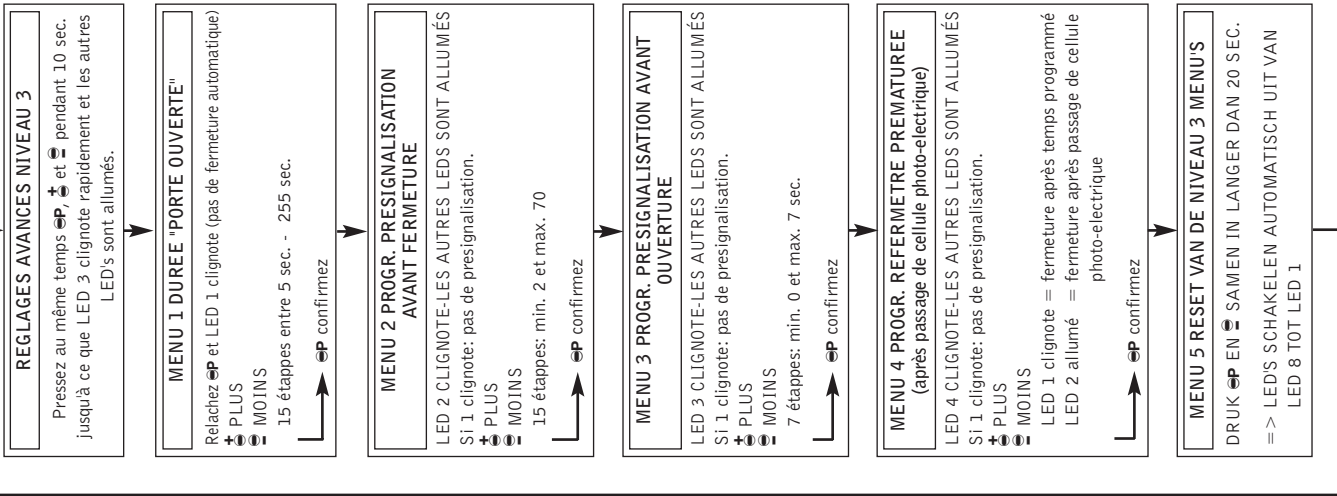
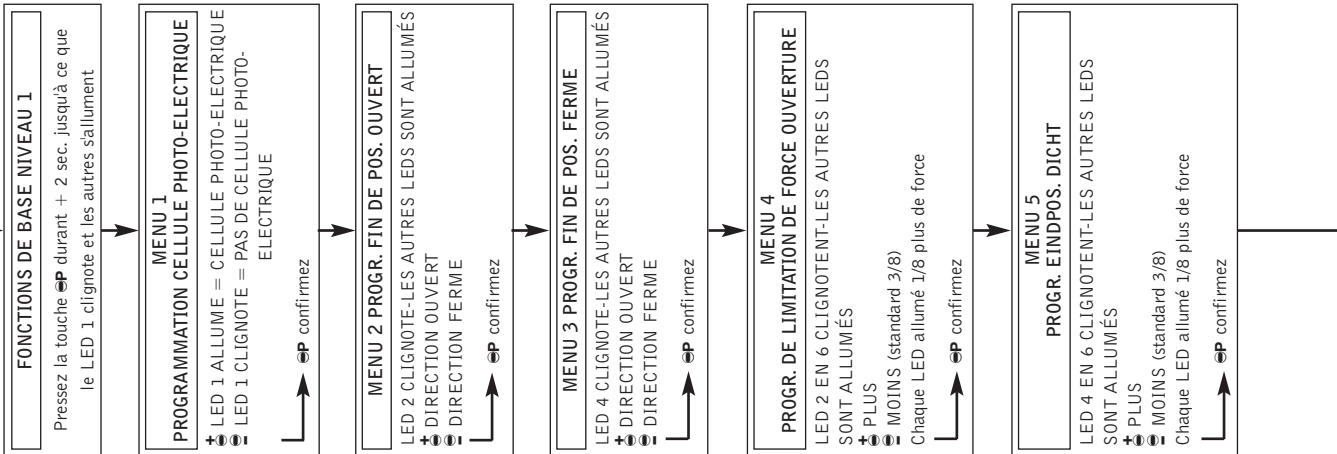

**ATTENTION! SI PENDANT LA PROGRAMMATION ON NE PRESSE AUCUNE DES TOUCHES DE PROGRAMMATION PENDANT 30 SECONDES, LE PROGRAMME S'ARRETERA.**

## OVERZICHT PROGRAMMERING MAC TRONIC 100

## Normale werking

**BASISFUNCTIES NIVEAU 1**  
Druk **EP** toets voor ongeveer 2 sec. in totdat LED 1 knippert en alle andere oplichten.

**MENU 1  
PROGRAMMERING FOTOCEL**  
LED 1 VERLICHT = FOTOCEL  
LED 1 KNIPPERT = GEEN FOTOCEL  
**EP** bevestigen

**MENU 2  
PROGR. EINDPOS. OPEN**  
LED 2 KNIPPERT - ALLE ANDERE LED'S VERLICHT.  
RICHTING OPEN  
RICHTING DICHT  
**EP** bevestigen

**MENU 3  
PROGR. EINDPOS. DICHT**  
LED 4 KNIPPERT - ALLE ANDERE LED'S VERLICHT.  
RICHTING OPEN  
RICHTING DICHT  
**EP** bevestigen

**MENU 4  
PROGR. MAX TREKKRACHT OPEN BEWEGING**  
LED 2 EN 6 KNIPPEN EN ALLE ANDERE LED'S ZIJN VERLICHT.  
MEER KRACHT  
MINDER KRACHT (standaard 3/8)  
Elke brandende LED 1/8 meer kracht  
**EP** bevestigen

**MENU 5  
PROGR. EINDPOS. DICHT**  
LED 4 EN 6 KNIPPEN EN ALLE ANDERE LED'S ZIJN VERLICHT.  
MEER KRACHT  
MINDER KRACHT (standaard 3/8)  
Elke brandende LED 1/8 meer kracht  
**EP** bevestigen

**GEAVANCEERDE INSTELLINGEN - NIVEAU 3**  
**EP**, **+** en **-** voor 10 sec. gezamenlijk indrukken tot LED 3 knippert en alle andere LED's oplichten.

**MENU 1 - TIJDSDUUR "DEUR OPEN"**  
Laat **EP** los en LED 1 knippert (geen automatische dichtloop)  
MEER  
MINDER  
15 stappen tussen 5 sec. - 225 sec.  
**EP** bevestigen

**MENU 2 PROGR. WAARSCHUWINGSTIJD**  
(voordat de deur sluit)  
LED 2 KNIPPERT - ALLE ANDERE LED'S VERLICHT.  
Indien 1 knippert geen voorschwaarschuwing.  
MEER  
MINDER  
7 stappen min 2 en max. 70 sec.  
**EP** bevestigen

**MENU 3 PROGR. WAARSCHUWINGSTIJD**  
(voordat de deur opengaat)  
LED 3 KNIPPERT - ALLE ANDERE LED'S VERLICHT.  
Indien 1 knippert geen voorschwaarschuwing.  
MEER  
MINDER  
7 stappen min 0 en max. 7 sec.  
**EP** bevestigen

**MENU 4 PROGR. VOORTIJDIG SLUITEN**  
(na passeren van fotocel)  
LED 4 KNIPPERT - ALLE ANDERE LED'S VERLICHT.  
MEER  
MINDER  
LED 1 knippert = autom. sluiting na ingestelde tijd  
LED 1 brandt = deur sluit na het passeren van de fotocel  
**EP** bevestigen

**MENU 5 RESET VAN DE NIVEAU 3 MENU'S**  
DRUK **EP** EN **-** SAMEN IN LANGER DAN 20 SEC.  
=> LED'S SCHAKELEN AUTOMATISCH UIT VAN LED 8 TOT LED 1

**GEAVANCEERDE INSTELLINGEN - NIVEAU 4**  
**EP**, **+** en **-** voor 10 sec. gezamenlijk indrukken, **EP** ingedrukt houden met **+** tot LED 4 knippert en alle andere LED's oplichten.

**MENU 1 - TIJDSDUUR "VERLICHT"**  
Laat **EP** los en LED 1 knippert en de andere zijn verlicht  
MEER  
MINDER (standaard 180 sec.)  
15 stappen tussen 90 sec. - 240 sec.  
**EP** bevestigen

**MENU 2 PROGR. "MEERKRACHT" VOLLE SNELHEID**  
LED 2 KNIPPERT - ALLE ANDERE LED'S VERLICHT.  
MEER  
MINDER  
LED 1 knippert indien geesactiveerd  
15 stappen (standaard 7/15)  
**EP** bevestigen

**MENU 3 PROGR. "MEERKRACHT" BIJ TRAGE SNELHEID**  
LED 3 KNIPPERT - ALLE ANDERE LED'S VERLICHT.  
MEER  
MINDER  
LED 1 knippert indien geesactiveerd  
15 stappen (standaard 7/15)  
**EP** bevestigen

**GEAVANCEERDE INSTELLINGEN - NIVEAU 5**  
**EP**, **+** en **-** voor 10 sec. gezamenlijk indrukken, **EP** ingedrukt houden met **+** tot LED 5 knippert en alle andere LED's oplichten.

**MENU 1 - PROG. LOOPTIJDSBEGRENZING**  
Laat **EP** los en LED 1 knippert en de andere zijn verlicht  
MEER  
MINDER (standaard 180 sec.)  
15 stappen tussen 30 sec. - 240 sec.  
**EP** bevestigen

**MENU 2 PROGR. EXTERNE SIGNAALLAMP**  
LED 2 KNIPPERT - ALLE ANDERE LED'S VERLICHT.  
MEER  
MINDER  
LED 1 knippert = ext. lamp brandt  
LED 1 brandt = ext. lamp knippert  
**EP** bevestigen

**MENU 3 PROGR. VERLICHT. AANDRIJVING**  
LED 3 KNIPPERT - ALLE ANDERE LED'S VERLICHT.  
MEER  
MINDER  
LED 1 knippert = verlicht. brandt gedurende de voorwaarschuwingstijd sluiten  
LED 1 brandt = verlicht. knippert gedurende de voorwaarschuwingstijd sluiten  
**EP** bevestigen

**MENU 4 PROGR. VERLICHTING EXT LICHTRELAIS (BOX)**  
LED 4 KNIPPERT - ALLE ANDERE LED'S VERLICHT.  
MEER  
MINDER  
LED 1 knippert = ext. verlichting brandt tijdens de voorafgeprogr. verlichtingsduur.  
LED 1 brandt = ext. lichtrelais geeft 30 sec. alarmmelding na activ. van beveiliging tegen ongewenst openen.  
**EP** bevestigen

**OPGELET! INDIEN TIJDENS DE PROGRAMMERINGSMODUS BINNEN 30 SEC. GEEN VAN DE 3 PROG. TOETSEN INGEDRUKT, WORDT HET PROGRAMMA AFGEBROKEN.**



# VEILIGHEIDSINSTRUCTIES VOOR DE GEBRUIKER



Modular Automation Corporation

MAC TRONIC 55 - 70 - 100



## Algemene veiligheidsinstructies.

Deze instructies zijn een essentieel onderdeel van het produkt en dienen afgegeven te worden aan de gebruiker. Gelieve deze instructies zorgvuldig door te nemen want zij bevatten belangrijke richtlijnen betreffende de veiligheid, het gebruik en het onderhoud van dit systeem. Het is onontbeerlijk om deze richtlijnen te bewaren en deze door te geven aan alle andere mogelijke gebruikers van de aandrijving. Deze motor mag enkel en alleen gebruikt worden waarvoor hij ontworpen is. Elk ander gebruik wordt aanzien als oneigenlijk en bijgevolg gevaarlijk. De machinebouwer kan niet verantwoordelijk gesteld worden voor eventuele schade veroorzaakt door ongeschikt, verkeerd of onverstandig gebruik. Vermijd elke handeling in de nabijheid van scharnieren of bewegende mechanische onderdelen. Begeef u niet in het onmiddellijk bewegingsveld van de automatische deur of poort wanneer deze in beweging is. Het tegenhouden van de bewegende automatische deur of poort kan een bron van gevaar zijn. Laat kinderen nooit spelen in het bewegingsveld van de geautomatiseerde deuren of poorten. Bewaar alle afstandsbedieningen of andere bedieningstoestellen buiten het bereik van kinderen, om elke onverwachte bediening te voorkomen. Ingeval van stroomonderbreking of slechte werking van de poort dient de stroom te worden onderbroken, en dient u zich te wenden tot een erkende installateur. Alle verantwoordelijkheid wordt afgewezen wanneer zou blijken dat er eigenhandige reparaties uitgevoerd werden. Het niet opvolgen van deze instructies kan gevaar met zich meebrengen. Alle tussenkomsten voor reiniging, onderhoud of herstelling dienen uitgevoerd te worden door geschoold personeel. Alle mogelijke documenten betreffende deze tussenkomsten dienen ter beschikking gesteld te worden van de gebruiker. Om de goede werking van het systeem te waarborgen is het onontbeerlijk deze instructies aandachtig te lezen en het periodiek onderhoud van de automatisatie te laten uitvoeren door een erkende installateur.

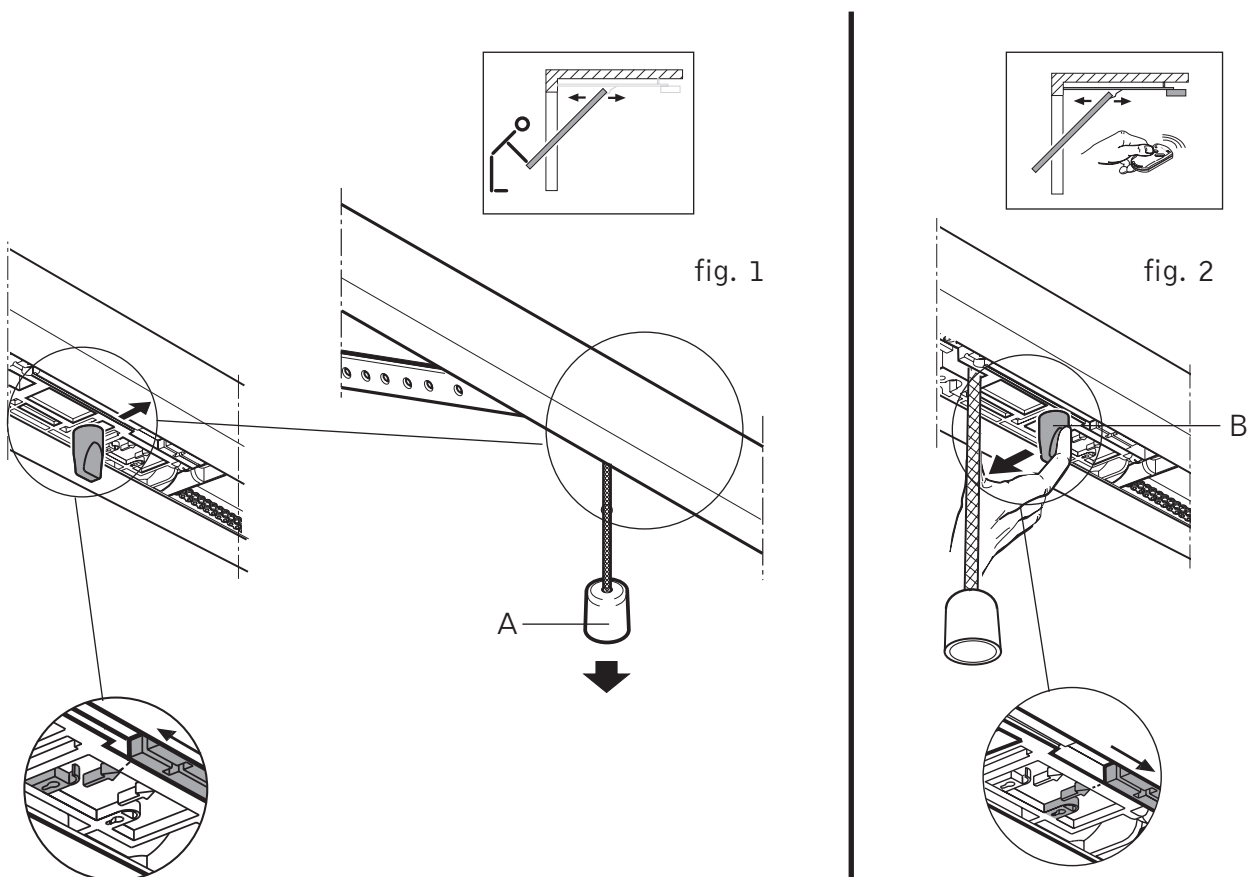

| ontgrendelen<br>manuele bediening (fig. 1)  | vergrendelen<br>automatische bediening (fig. 2)   |
|---|---|
| Trek aan de touw (a), het loopwagentje is ontgrendeld.<br>De poort kan nu manueel bediend worden. | Beweeg de rode pal in de richting van de pijl.<br>Het loopwagentje wordt terug vergrendeld. De poort kan nu opnieuw automatisch bediend worden. |

# INSTRUCTIONS DE SECURITE POUR L'UTILISATEUR



MAC TRONIC 55 - 70 - 100



## Consignes générales de sécurité

Ces consignes font partie intégrante en essentielle du produit et doivent être remises à l'utilisateur. Lire ces consignes attentivement, car elles contiennent des instructions concernant la sécurité de l'installation, de l'utilisation et de l'entretien de ce système. Il est indispensable de conserver ces instructions et de les transmettre à d'autres utilisateurs éventuels de ce système. Ce produit doit être destiné exclusivement à l'utilisation pour laquelle il a été conçu. Toute autre utilisation est inappropriée et par conséquent dangereuse. Le constructeur ne peut être tenu pour responsable en cas d'éventuels dommages causés par une utilisation inappropriée, erronée et irrationnelle.

Eviter de manoeuvrer à proximité des charnières ou des organes mécaniques en mouvement. Ne pas entrer dans le rayon d'action de la porte ou du portail automatisés lorsqu'ils sont en mouvement. Ne pas s'apposer au mouvement de la porte ou du portail automatisés car cela peut être source de danger. Ne pas laisser des enfants se tenir ou jouer dans le rayon d'action de la porte ou du portail automatisés. Garder les radiocommandes et/ou tout autre dispositif de commande hors de la portée des enfants afin d'éviter que la porte ou le portail automatisés puissent être actionnés involontairement. En cas de panne ou de mauvais fonctionnement du produit, débrancher l'interrupteur de secteur et s'abstenir de tout tentative de réparation ou d'intervention directe.

S'adresser uniquement à un professionnel compétent. Le non-respect de ces instructions peut être cause de danger. Toute intervention de nettoyage, d'entretien ou de réparation doit être effectuée par du personnel expérimenté et qualifié. Afin de garantir l'efficacité du système et son fonctionnement correct, il est indispensable de lire attentivement les instructions du constructeur en s'adressant à un professionnel compétent pour l'entretien périodique de la porte ou du portail automatisés. Les interventions d'installation, d'entretien et de réparation doivent être documentées et mises à la disposition de l'utilisateur.

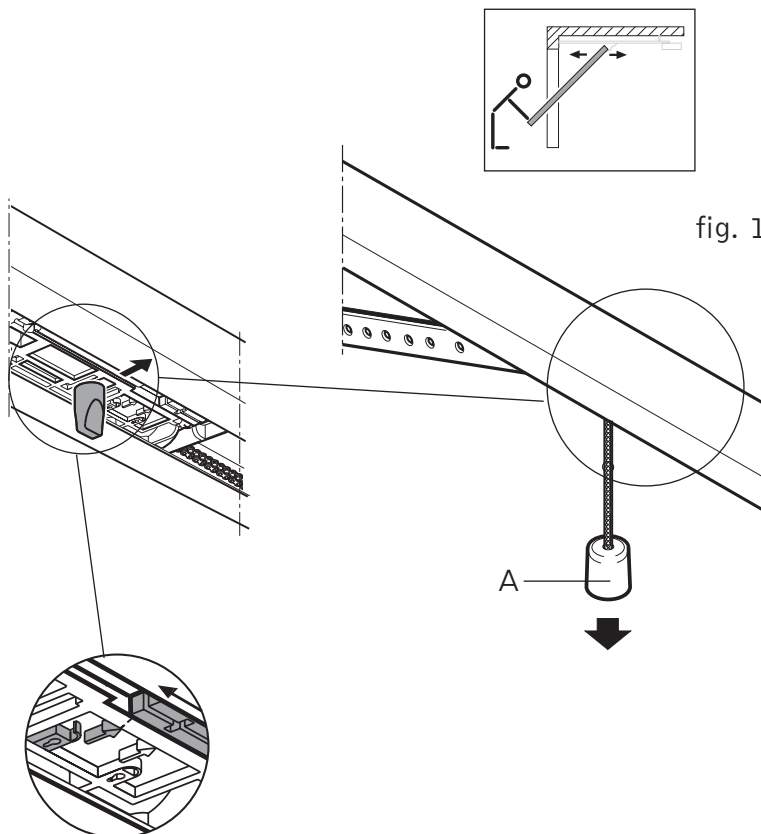

fig. 1

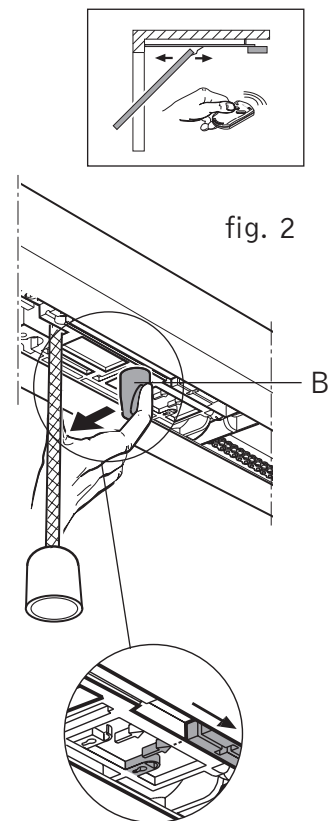

fig. 2

| <p>déverrouiller<br/>ouverture à la main (fig. 1)</p>   | <p>verrouiller<br/>ouverture automatique (fig. 2)</p>   |
|---|---|
| <p>Pour déverrouiller le chariot : tirez la corde (a).<br/>Le chariot reste déverrouillé. On peut ouvrir la porte manuellement.</p> | <p>Pour remettre le chariot en marche: bougez le levier rouge dans le sens de la flèche et démarrez l'ouvre-porte.<br/>La porte est prête pour l'ouverture automatique.</p> |